

1 FUNGSI DAN PERSAMAAN KUADRATIK		
<p>1.</p> $2x^2 - 10x = x - 15$ $2x^2 - 11x + 15 = 0$ $(2x - 5)(x - 3) = 0$ $x = \frac{5}{2}, \quad x = 3$ <p>2.</p> $2h + 12 = 3h^2 - 3h$ $0 = 3h^2 - 5h - 12$ $0 = (3h + 4)(h - 3)$ $h = -\frac{4}{3}, \quad h = 3$ <p>3.</p> $4y^2 - 3 = -4y$ $4y^2 + 4y - 3 = 0$ $(2y + 3)(2y - 1) = 0$ $x = -\frac{3}{2}, \quad x = \frac{1}{2}$ <p>4.</p> $4(2 + m) = m(3m - 1)$ $8 + 4m = 3m^2 - m$ $0 = 3m^2 - 5m - 8$ $0 = (3m - 8)(m + 1)$ $m = \frac{8}{3}, \quad m = -1$	<p>5.</p> <p>i) A(15,0)</p> <p>ii)</p> $x^2 - 2x - 15 = 0$ $(x + 3)(x - 5) = 0$ $x = -3, \quad x = 5$ <p>B(-3, 0)</p> <p>iii) C(5,0)</p> <p>iv)</p> $\frac{-3 + 5}{2} = 1$ <p>Paksi simetri: $x = 1$</p> <p>6.</p> <p>i) $m = 1, \quad n = 7$</p> $f(x) = a(x - m)(x - n)$ $14 = a(0 - 1)(0 - 7)$ <p>$a = 2$</p> <p>ii)</p> $x = \frac{1 + 7}{2} = 4$ $f(x) = 2(4 - 1)(4 - 7)$ $f(x) = -18$ <p>P(4, -18)</p> <p>7.</p> $\frac{1}{2}(x + 1 + 4x - 3)(2x) = 168$ $x(5x - 2) = 168$ $5x^2 - 2x - 168 = 0$ $(5x + 28)(x - 6) = 0$ $x = -\frac{28}{5}, \quad x = 6$ <p>Panjang RS = $4(6) - 3 = 21$</p>	<p>8.</p> $0 = -2t^2 + 9t - 5$ $2t^2 - 9t + 5 = 0$ $(2t + 1)(t - 5) = 0$ $t = -\frac{1}{2}, \quad t = 5$ <p>9.</p> $\frac{1}{3}\pi(x^2)(6) = (7x + 4)\pi$ $2x^2 - 7x - 4 = 0$ $(2x + 1)(x - 4) = 0$ $x = -\frac{1}{2}, \quad x = 4$ <p>Jejari bula tan, $x = 4$</p> <p>10.</p> $(x + 4)(x + 3) = (2x + 2)(x + 1)$ $x^2 + 7x + 12 = 2x^2 + 4x + 2$ $0 = x^2 - 3x - 10$ $0 = (x + 2)(x - 5)$ $x = -2, \quad x = 5$ <p>Panjang sisiempat B = $2(5) + 2 = 12$</p>

2 ASAS NOMBOR	
1. (a) 410 (b) 210 (c) 151	2. (a) 448 (b) 1080 (c) 8
3. 5833	4. 2525
5. 50 ₉	6. 102 ₆
7. 1268	8. 244 ₇
9. (a) 385 (b) 2212 ₃	10. $x = 7$

3

PENAAKULAN LOGIK

1. i) Benar ii) Palsu iii) Palsu iv) Benar v) Benar	2. i) Sebilangan ii) Semua iii) Semua iv) Sebilangan
3. i) Implikasi 1 : Jika $A \subset B$ maka $A \cap B = A$ Implikasi 2 : Jika $A \cap B = A$ maka $A \subset B$ ii) Implikasi 1 : Jika $AB = BC = AC$ maka ABC ialah poligon sekata Implikasi 2 : Jika ABC ialah poligon sekata maka $AB = BC = AC$	4. i) Akas : Jika $x = 14$ maka $x - 5 = 9$ Songsangan : Jika $x - 5 \neq 9$ maka $x \neq 9$ Kontrapositif : Jika $x \neq 14$ maka $x - 5 \neq 9$ ii) Akas : Jika koordinat $-x$ bagi k ialah sifar maka k adalah titik pada paksi $-y$ Songsangan : Jika k bukan titik pada paksi $-y$ maka koordinat bagi k bukan sifar. Kontrapositif : Jika koordinat $-x$ bagi k bukan sifar maka k bukan titik paksi $-y$
5. Kesimpulan : $3 + (n)^2, n = 1,2,3,4, \dots$ [titik sekurang2nya tiga]	6. Kesimpulan : $2(1 + n)^2 - n^2, n = 1,2,3,4, \dots$
7. i) Kesimpulan : Pepejal geometri p mempunyai 6 permukaan ii) Kesimpulan : Set p mempunyai ; 2^5 subset iii) Kesimpulan : Set p tidak mempunyai 5 unsur	8. a) Premis 2 : poligon Q tidak mempunyai satu sudut tegak b) Semua c) Akas : Jika $p^2 > 0$ maka $p < 0$, benar
9. a) Hujah itu lemah dan tidak menyakinkan kerana premis adalah benar tetapi kesimpulan palsu. b) Hujah itu kuat dan menyakinkan kerana semua premis dan kesimpulan benar. c) Hujah itu kuat dan tidak meyakinkan kerana premis 1 adalah palsu. d) Hujah itu lemah dan tidak meyakinkan kerana kesimpulan mungkin palsu.	10. a) ABCDEFGH mempunyai 8 sisi. b) Palsu. c) Jika $\theta = 30^\circ$ maka $\sin \theta = 0.5$. atau Jika $\sin \theta = 0.5$ maka $\theta = 30^\circ$ d) (i) $n^3 + 3, n = 1,2,3,4, \dots$ (ii) $n^2, n = 1,2,3,4, \dots$
11. a) Pernyataan - ayat palsu b) Palsu c) Jika P bukan gandaan 5, maka P tidak boleh dibahagi tepat dengan 5. d) $4(n) - n, n = 1,2,3,4, \dots$	12. a) Premis 1: Jika PQ dan RS selari maka PQ dan RS selari maka PQ dan RS mempunyai kecerunan yang sama. b) Palsu c) $3(n^2) - 4, n = 2,3,4,5, \dots$ $x = \frac{71}{2}$ d) Implikasi 1 : Jika Ahmad seorang yang cerdik maka Ahmad rajin membaca buku. Implikasi 2 : Jika Ahmad rajin membaca buku maka Ahmad seorang yang cerdik.
13. a) 13 kg RM 5 b) $2500 \left(1 + \frac{1}{20}\right)^5$ RM 3191	14. $4 \left(\frac{1}{2} \times \frac{22}{7} \times 14 \times 14 \right)$ 1232 cm ²
15. a) " $3 + (-8) \neq 11$ " b) (i) Semua segi empat mempunyai jumlah sudut pedalaman 360° (ii) Gajah ialah mamalia.	16. a) $(101 - 100) (101 + 100)$ 201 b) (i) Induktif (ii) deduktif

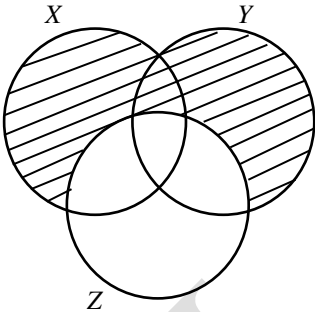
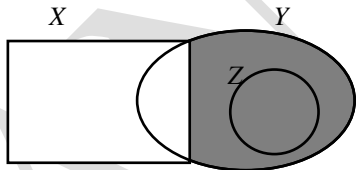
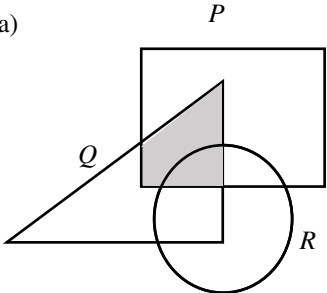
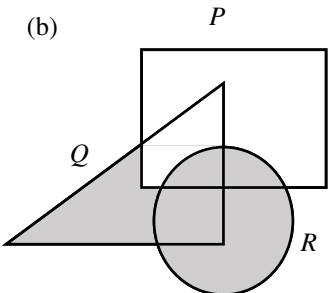
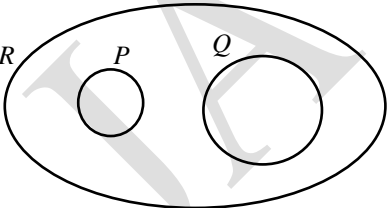
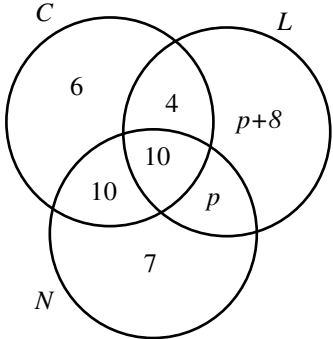
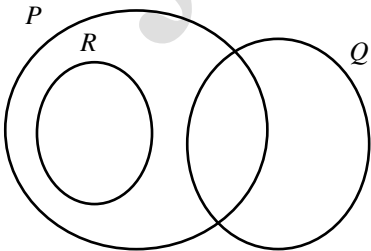
4	OPERASI SET	ZURAMI
1	(a) $\{\}$ (b) N (c) M	6
2	(a) $\{1,9\}$ (b) $\{9\}$	(a) 
3	(a) $P = \{3, 6, 9, 12, 15, 18\}$ (b) $Q = \{2, 4, 5, 10, 20\}$ (c) $R = \{10, 12, 14, 16, 18\}$ (d) $P \cap R = \{12, 18\}$ (e) $Q \cup R = \{2, 4, 5, 10, 12, 14, 16, 18, 20\}$	(b) 
4	(a) 	7
5	(b) 	(a) $P \cup (Q \cap R)$ (b) $P' \cap R \cup X$ 8 $x = 10$ 9 (a) $r = 22$ (b) i) $t = 11$ ii) 155
5	(a) 	10 (a) 
	(b) 	(b) $p = 5$ (c) 25

5

RANGKAIAN DALAM TEORI GRAF

1. (i) $V = \{A, B, C, D\}$
 (ii) $E = \{(A, B), (B, B), (B, C), (B, C), (B, D), (D, C)\}$
 (iii) $n(V) = 6$
 $\Sigma d(V) = 2(6)$
 $= 12$

2.

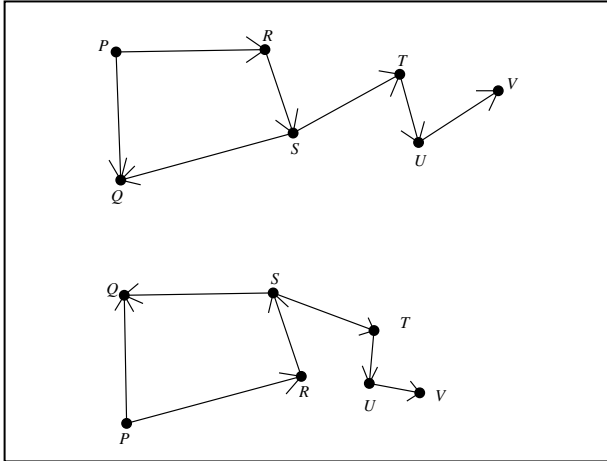

3.

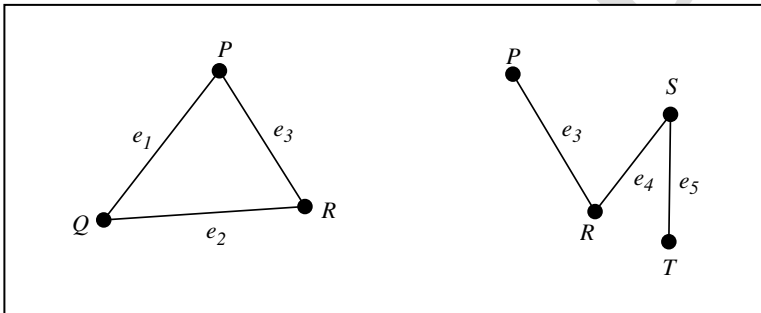

4. Bukan pokok kerana wujudnya kitaran atau $n(E) = 7$
 $n(V) = 7, n(E) \neq n(V) - 1$

5.

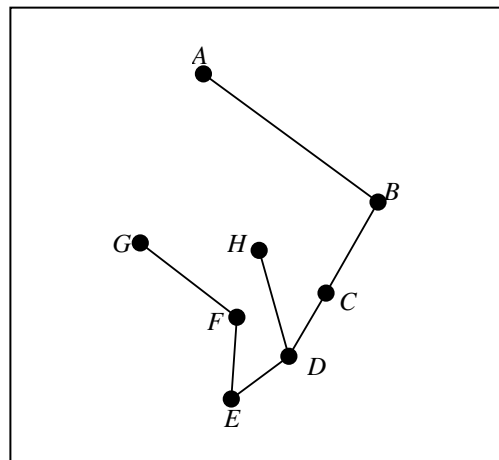
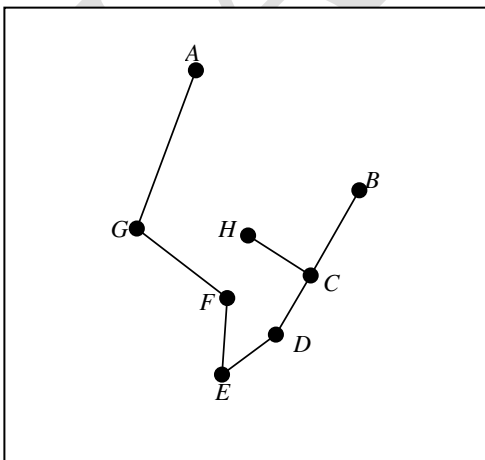

6.

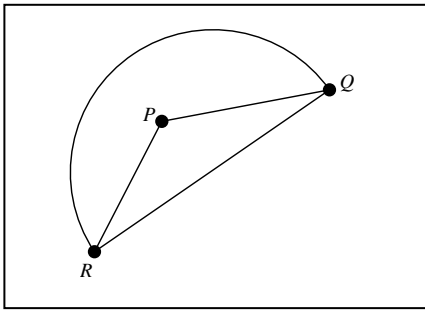

7. (a) Sebab terbentuk rangkaian daripada suatu siri bintit yang disambung antara satu sama lain melalui garis bagi tempat-tempat tersebut.
 (b) Bucu mewakili tempat
 Tepi mewakili
 Stesen Minyak

8. $P \rightarrow U \rightarrow T \rightarrow S$

12 km

9.

ξ

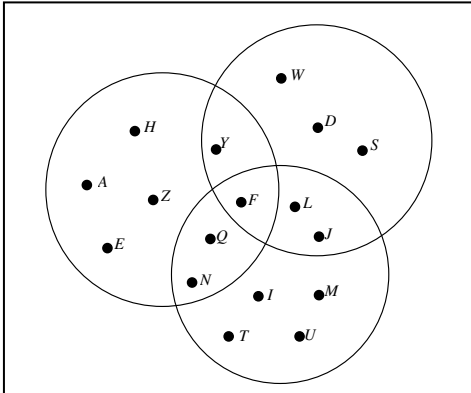

10. (a)

(i) $S \rightarrow KB \rightarrow KR \rightarrow J \rightarrow K$ (ii) $S \rightarrow KB \rightarrow J \rightarrow K$ (iii) $S \rightarrow J \rightarrow K$ (iv) $S \rightarrow PP \rightarrow J \rightarrow K$

- (b) (i) 45 km
 (ii) 44 km
 (iii) 43 km
 (iv) 59 km

- (c) (i) RM67.50
 (ii) RM66.00
 (iii) RM64.50
 (iv) RM88.50

Pilih laluan $S \rightarrow J \rightarrow K$ sebab jarak lebih dekat dan tambang lebih murah

6

KETAKSAMAAN LINEAR

1.

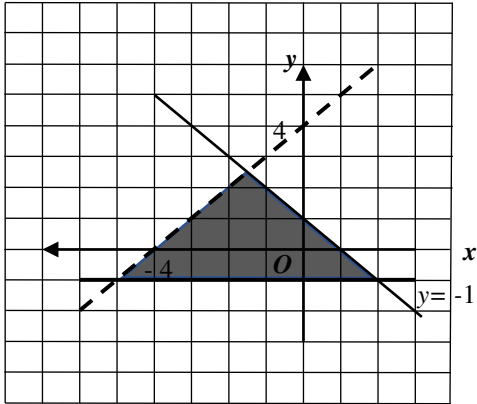
2. $x < 4$

3. (a) $y = -2x + 3$ (b) $y > -2x + 3$ (c) $y < -2x + 3$

4.

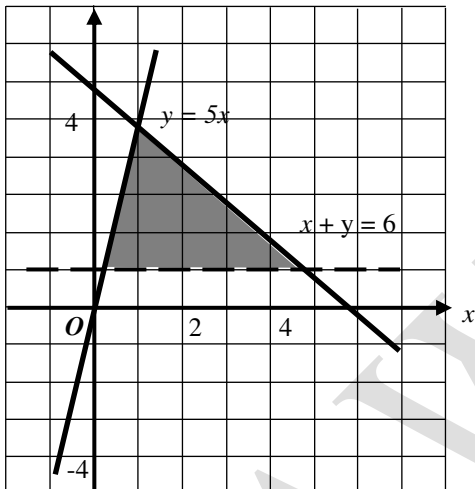

7.

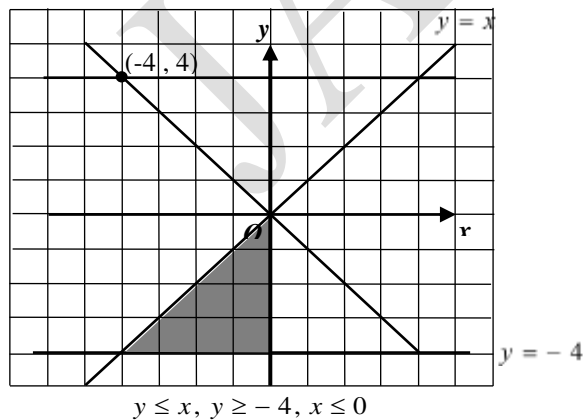
8. $x + y \leq 20$ dan $x \geq 3y$

5.

(a) (i) $x \geq 0$ (ii) $y \geq 0$ (iii) $y < 5 - x$ (b) (i) $x \leq 0$ (ii) $y > -3x - 6$ (iii) $y \geq 2x - 6$

6. (a)

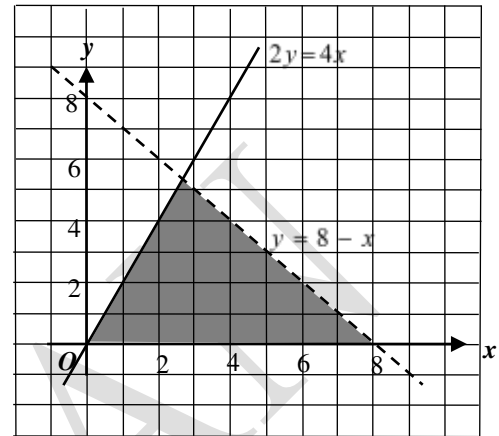

(b)

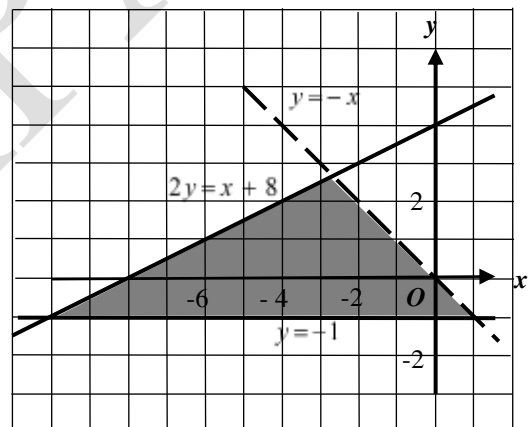

9.

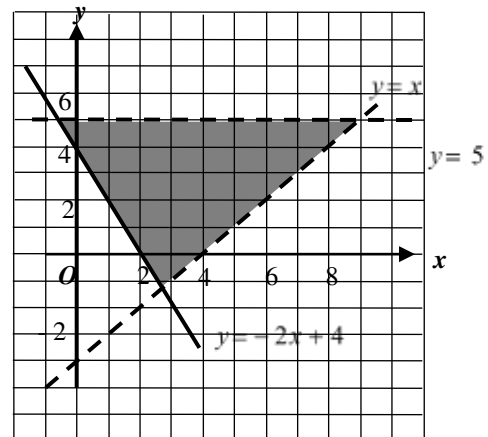
10. $y < 3x$, $y \geq \frac{1}{2}x$, $y < 6 - x$

GRAF GERAKAN

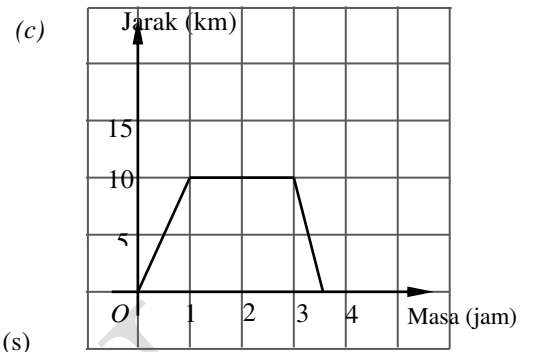
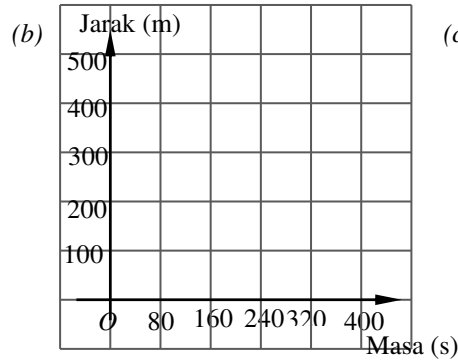
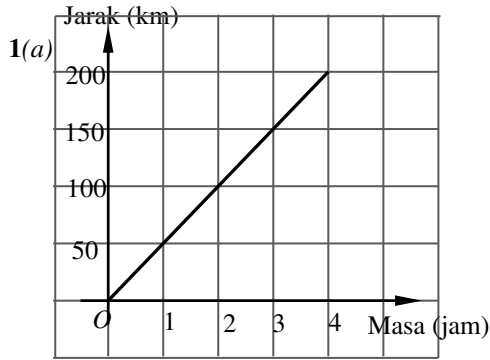

(a) (i) 10 kmj^{-1}

(ii) 20 kmj^{-1}

(i) 1 jam

(ii) 5.71 kmj^{-1}

(b) (i) Bas bergerak sejauh 10 km dalam tempoh 1 jam dengan laju purata 10 kmj^{-1}

(ii) Teksi bergerak sejauh 10 km dalam tempoh setengah jam dengan laju purata 20 kmj^{-1}

2 (a) (i) 4
(ii) 360
(iii) 240

(b) Kereta bergerak sejauh 20 km dalam tempoh masa 5 minit dengan laju purata 240 kmj^{-1}

3 (a) 110
(b) (i) 13
(ii) 3.67

(c) zarah bergerak sejauh 50 meter dalam masa 5 saat dengan laju purata 10 ms^{-1}

4 (a) 0.3
(b) 2
(c) 113.3
(d) kereta bergerak sejauh 170 km selama 2 jam dengan laju purata 85 kmj^{-1}

5 (a) 30
(b) (i) 270
(ii) 180
(iii) 5
(c) 90

6 (a) 6
(b) zarah mengalami pecutan dengan kadar 6 ms^{-2} untuk tempoh 2 saat
(c) 12
(d) 5

(e) 60
(f) zarah bergerak dengan laju seragam 12 ms^{-1} untuk tempoh 5 saat
(g) 84
(h) 8.4

7 (a) 4
(b) 9
(c) 13

8 (a) 900
(b) 3.75
(c) 380

9 (a) motorsikal bergerak dengan laju seragam 150 kmj^{-1} untuk tempoh 2 jam.
(b) -100 atau nyah pecutan = 100
(c) 90

10 (a) 75
(b) 0.5
(c) 80

8

SUKATAN SERAKAN DATA TAK TERKUMPUL

1. $8 - 0 = 8$

2. $10 - 5 = 5$

3. $P \leq \text{Elektrik (RM)} \leq Q$
 $P = 140$
 $Q = 400$
 $\text{Beza} = 400 - 140 = 260$

4.

Plot batang-dan-daun

Acara Larian							Acara Meniup Belon						
8	7	5	2	1	1	0	2	0	0	3	4		
			4	4	3	2	3	2	3	3	5	5	8
					6	5	4	0	1	1	3		
				3	3	2	5	3	1				
					1	0	6	4	5				

Kekunci : $0 | 2 | 0$ bermakna 20 tahun bagi umur peserta acara lari dan 20 tahun bagi umur peserta acara meniup belon.

- (a) Beza umur peserta acara larian = $61 - 20 = 41$
 Beza umur peserta acara meniup belon = $65 - 20 = 45$
 Maka, serakan umur peserta acara meniup belon lebih besar kerana beza lebih besar.
- (b) Secara umumnya, kebanyakan peserta yang hadir acara larian adalah lebih muda berbanding peserta yang hadir acara meniup belon kerana kebanyakan cerapan tertumpu di bahagian atas plot.

5.

Plot titik

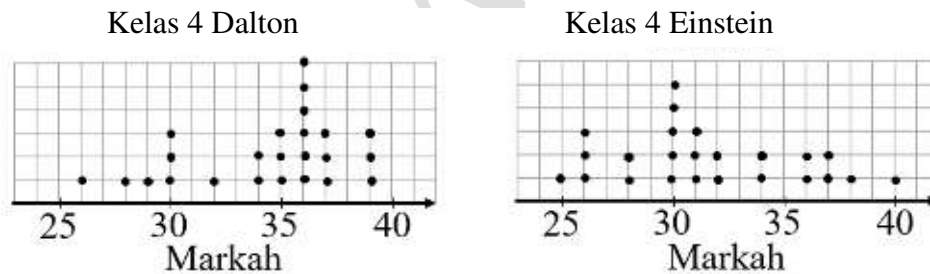

- (a) Beza kelas 4 Dalton = $39 - 26 = 13$
 Beza kelas 4 Einstein = $40 - 25 = 15$
 Maka, serakan kelas 4 Einstein lebih besar kerana beza lebih besar
- (b) Secara umumnya murid-murid kelas 4 Dalton berjaya mencatatkan pencapaian yang lebih baik kerana kebanyakan cerapan tertumpu di sebelah kanan plot titik. Maka, kelas 4 Dalton yang akan menerima hadiah tersebut.

6. S ialah cerapan terbesar, maka $S = 9$
 R ialah cerapan terkecil, maka $R = 3$
 Julat minimum = $9 - 3 = 6$

7. Susunan: 22, **23**, **24**, 24, **25**, 26, **26**, **27**, 28
 $Q1 = 23.5$
 $Q3 = 26.5$
 Julat antara kuartil = $Q3 - Q1 = 26.5 - 23.5 = 3$

8.

Buku yang dibawa	3	4	5	6	7	8
Bil. Pelajar	4	5	11	6	8	2
Kekerapan longgokan	4	9	20	26	34	36
Cerapan	C ₁ -C ₄	C ₅ -C ₉	C ₁₀ -C ₂₀	C ₂₁ -C ₂₆	C ₂₇ -C ₃₄	C ₃₅ -C ₃₆

Q1 = Cerapan ke - (14×36) = Cerapan ke - 9 = RM 4

Q3 = Cerapan ke - (34×36) = Cerapan ke - 27 = RM7

Julat antara kuartil = Q3 - Q1 = 7 - 4 = 3

$$9. \quad \text{Min, } \bar{X} = \frac{\sum x}{N} = \frac{21+23+26+19+18+27+22+20}{8} = 22$$

$$\begin{aligned} \text{Varians, } \sigma^2 &= \frac{\sum x^2}{N} - \bar{X}^2 \\ &= \frac{21^2 + 23^2 + 26^2 + 19^2 + 18^2 + 27^2 + 22^2 + 20^2}{8} - 22^2 = 9 \end{aligned}$$

$$\text{Sisihan piawai, } \sigma = \sqrt{9} = 3$$

$$10. \quad \text{Min, } \bar{X} = \frac{\sum fx}{\sum f} = \frac{3(1)+5(2)+3(3)+6(4)+3(5)}{3+5+3+6+3} = 3.05$$

$$\begin{aligned} \text{Varians, } \sigma^2 &= \frac{\sum fx^2}{\sum f} - \bar{X}^2 \\ &= \frac{3(1)^2 + 5(2)^2 + 3(3)^2 + 6(4)^2 + 3(5)^2}{20} - 3.05^2 = 1.7475 \end{aligned}$$

$$\text{Sisihan piawai, } \sigma = \sqrt{1.7475} = 1.3219$$

11. (a)

$$\text{Min, } \bar{X} = \frac{\sum x}{N} = \frac{8+8+9+10+12+14+15}{7} = 10.8571$$

$$(b) \text{Min, } \bar{X} = \frac{\sum x}{N} = \frac{16+16+18+20+24+28+30}{7} = 21.7143$$

$$\begin{aligned} \text{Sisihan piawai, } \sigma &= \sqrt{\frac{\sum x^2}{N} - \bar{X}^2} \\ &= \sqrt{\frac{8^2+8^2+9^2+10^2+12^2+14^2+15^2}{7} - 10.8571^2} \\ &= 2.642 \end{aligned}$$

$$\begin{aligned} \text{Sisihan piawai, } \sigma &= \sqrt{\frac{\sum x^2}{N} - \bar{X}^2} \\ &= \sqrt{\frac{16^2+16^2+18^2+20^2+24^2+28^2+30^2}{7} - 21.7143^2} \\ &= 5.284 \end{aligned}$$

(c) Sisihan piawai baharu = sisihan piawai asal × 2

12. Sukatan serakan yang paling sesuai = Sisihan piawai
 Kerana ini merupakan data perbandingan antara 2 pelajar

Murni :

$$\text{Min, } \bar{X} = \frac{\sum x}{N} = \frac{85+79+83+90+87}{5} = 84.8$$

$$\begin{aligned} \text{Varians, } \sigma^2 &= \frac{\sum X^2}{N} - \bar{X}^2 \\ &= \frac{85^2 + 79^2 + 83^2 + 90^2 + 87^2}{5} - 84.8^2 = 13.76 \end{aligned}$$

$$\text{Sisihan piawai, } \sigma = \sqrt{13.76} = 3.7094$$

Ahmad :

$$\text{Min, } \bar{X} = \frac{\sum x}{N} = \frac{92+71+90+89+88}{5} = 86$$

$$\begin{aligned} \text{Varians, } \sigma^2 &= \frac{\sum X^2}{N} - \bar{X}^2 \\ &= \frac{92^2 + 71^2 + 90^2 + 89^2 + 88^2}{5} - 86^2 = 58 \end{aligned}$$

$$\text{Sisihan piawai, } \sigma = \sqrt{58} = 7.6158$$

Murni lebih konsisten kerana sisihan piawai yang lebih kecil

13. Susun tertib menaik:
 20, 20, 20, 20, 21, 21, 21, 23, 23, 24, 24, 24, 25, 25, 25, 26, 26, 27, 27, 28, 28, 28

Nilai Minimum	Kuartil 1	Median	Kuartil 2	Nilai Maksimum
20	21	24	26	28

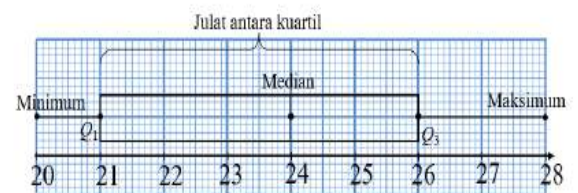

14.

Nilai minimum	= 12.3
Nilai maksimum	= 17.9
Kuartil 1, Q1	= 13.8
Median	= 14.6
Kuartil 3, Q3	= 17.3
Julat data	= 17.9 - 12.3 = 5.6
Julat antara kuartil	= 17.3 - 13.8 = 3.5

15. (a) $\text{Min, } \bar{X} = \frac{\sum x}{N} = \frac{8+9+9+12+14+15+16}{7} = 11.86$

$$\begin{aligned} \text{Sisihan piawai, } \sigma &= \sqrt{\frac{\sum x^2}{N} - \bar{X}^2} \\ &= \sqrt{\frac{8^2+9^2+9^2+12^2+14^2+15^2+16^2}{7} - 11.86^2} \\ &= 2.9853 \end{aligned}$$

(b) $\text{Min, } \bar{X} = \frac{\sum x}{N} = \frac{9+9+12+14+15+16}{6} = 12.5$

$$\begin{aligned} \text{Sisihan piawai, } \sigma &= \sqrt{\frac{\sum x^2}{N} - \bar{X}^2} \\ &= \sqrt{\frac{9^2+9^2+18^2+12^2+14^2+15^2+16^2}{6} - 12.5^2} \\ &= 2.7538 \end{aligned}$$

- (c) Nilai min dan sisihan piawai baharu telah berubah. Mengeluarkan nilai cerapan yang jauh dari min akan mengecilkkan sisihan piawai

16. (a)

$$\begin{aligned} \text{Min} &= \frac{4+10+p+(p+3)+14+15+17+19}{8} = 13 \\ 82+2p &= 104 \\ p &= 11 \end{aligned}$$

(b)

$$\begin{aligned} \text{Varians, } \sigma^2 &= \frac{\sum x^2}{N} - \bar{X}^2 \\ &= \frac{4^2+10^2+11^2+14^2+14^2+15^2+17^2+19^2}{8} - 13^2 \\ &= 19 \end{aligned}$$

(c) Pencilan dikeluarkan (Keluarkan 4)

Set data baharu setelah didarab dengan 2 ialah 20,22,28,28,30,34,38

$$\text{Min} = \frac{20+22+28+28+30+34+38}{7} = 28.57$$

$$\begin{aligned} \text{Sisihan piawai, } \sigma &= \sqrt{\frac{\sum x^2}{N} - \bar{X}^2} \\ &= \sqrt{\frac{20^2+22^2+28^2+28^2+30^2+34^2+38^2}{7} - 28.57^2} \\ &= 5.8345 \end{aligned}$$

17. LelakiPerempuanGabungan

$$\text{Min} = 57 = \frac{\sum x}{14}$$

$$\sum x = 57 \times 14 = 798$$

$$\text{Min} = 43 = \frac{\sum x}{16}$$

$$\sum x = 43 \times 16 = 688$$

$$\text{Min baru, } \bar{X} = \frac{\sum x}{N} = \frac{798+688}{30} = 49.53$$

$$\text{Varians} = 2.6 = \frac{\sum x^2}{14} - 57^2$$

$$\begin{aligned} \sum x^2 &= 14(2.6+57^2) \\ &= 45522.4 \end{aligned}$$

$$\text{Varians} = 1.9 = \frac{\sum x^2}{16} - 43^2$$

$$\begin{aligned} \sum x^2 &= 16(1.9+43^2) \\ &= 29614.4 \end{aligned}$$

$$\begin{aligned} \text{Sisihan piawai, } \sigma &= \sqrt{\frac{\sum x^2}{N} - \bar{X}^2} \\ &= \sqrt{\frac{(45522.4+29614.4)}{30} - 49.53^2} \\ &= 7.1651 \end{aligned}$$

9

KEBARANGKALIAN PERISTIWA BERGABUNG

1. (a) $\{(A, A), (A, G), (G, A), (G, G)\}$

(b) $\{(M, B_1), (M, B_2), (M, H), (B_1, M), (B_1, B_2), (B_1, H), (B_2, B_1), (B_2, M), (B_2, H), (H, M), (H, B_1), (H, B_2)\}$

2. (a) $\frac{1}{15}$

(b) $\frac{9}{30}$

3. $\left(\frac{3}{6} \times \frac{2}{5}\right) + \left(\frac{3}{6} \times \frac{1}{5}\right) + \left(\frac{2}{6} \times \frac{3}{5}\right) + \left(\frac{2}{6} \times \frac{1}{5}\right) + \left(\frac{1}{6} \times \frac{3}{6}\right) + \left(\frac{1}{6} \times \frac{2}{6}\right)$
 $= \frac{127}{180}$

4. (i) $\frac{3}{4} \times \frac{2}{5} = \frac{3}{10}$

(ii) $\left(\frac{3}{4} \times \frac{3}{5}\right) + \left(\frac{1}{4} \times \frac{2}{5}\right) = \frac{11}{20}$

6. (a)

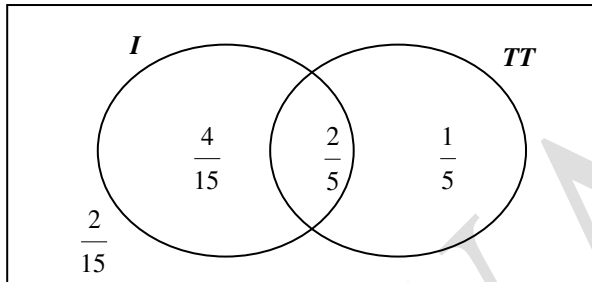

(b) $\frac{4}{15} + \frac{2}{5} + \frac{1}{5} = \frac{13}{15}$

$= \frac{13}{15}$

(c) $\frac{1}{5} \times 110 = 22$

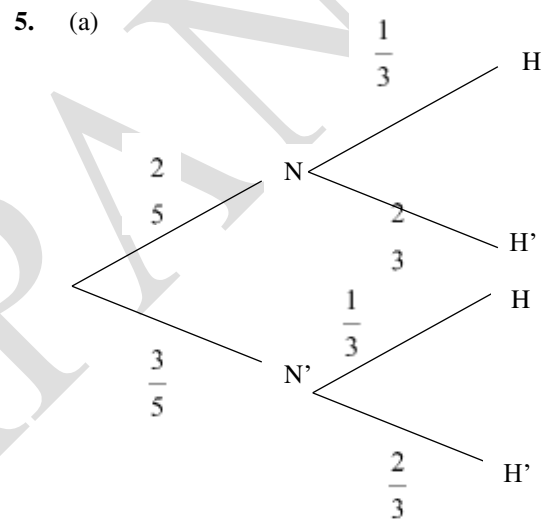

$\frac{2}{5} \times \frac{2}{3} + \frac{3}{5} \times \frac{1}{3}$

$\frac{7}{15}$

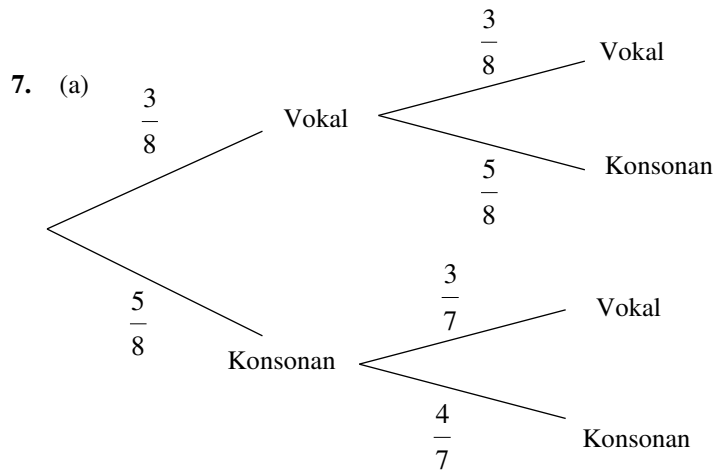

(b) i- $\frac{5}{8} \times \frac{4}{7} = \frac{5}{14}$

ii- $\frac{3}{8} \times \frac{5}{8} + \frac{5}{8} \times \frac{3}{7} = \frac{225}{448}$

8. (a) $\{14, 16, 19, 54, 56, 59, 64, 66, 69, 94, 96, 99\}$

(b) i- $\{19, 59, 69, 99\}$

kebarangkalian = $\frac{4}{12} = \frac{1}{3}$

ii- $\{19, 59, 64, 66, 99\}$

kebarangkalian = $\frac{5}{12}$

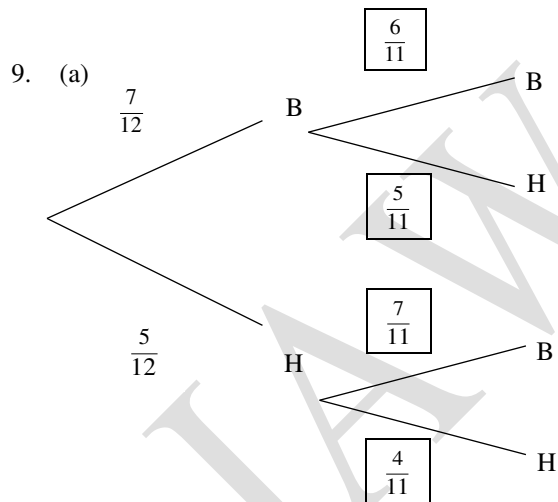

(b) i- $\left(\frac{7}{12} \times \frac{5}{11}\right) + \left(\frac{5}{12} \times \frac{4}{11}\right) = \frac{5}{12}$

ii- $\left(\frac{7}{12} \times \frac{5}{11}\right) + \left(\frac{5}{12} \times \frac{7}{11}\right) = \frac{35}{66}$

10.

Penerima Vaksin 1

Penerima Vaksin 2

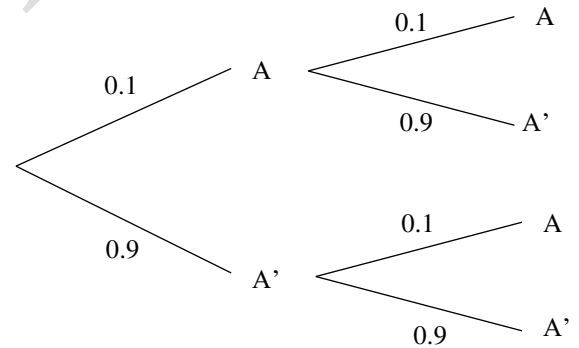

a) $(0.1 \times 0.1) + (0.1 \times 0.9) = 0.1$

b) $(0.1 \times 0.9) + (0.9 \times 0.1) + (0.9 \times 0.9) = 0.99$

10

MATEMATIK PENGGUNA: PENGURUSAN KEWANGAN

<p>1. (a) Pendapatan (Gaji + Kedai Sewa) $RM\ 3400 + RM\ 700 = RM\ 4100$ Aliran Tunai (Pendapatan-Perbelanjaan) $RM\ 4100 - (RM\ 1500 + RM\ 1700)$ $RM\ 900 @$ Aliran Tunai Positif $RM\ 900$</p>	<p>(b) Pembelanjaan tidak Tetap $(\frac{120}{100} \times 1700) = 2040$ Aliran Tunai $RM\ 3400 - (RM\ 1500 + RM\ 2040)$ Aliran Tunai Negatif $RM\ 140$ kerana perbelanjaan melebihi pendapatan</p>
<p>2. Aliran tunai (Pendapatan – Pembelanjaan) $RM\ (2000 + 800) @ (200 + 500 + 250 + 490 + 250) @ 2800 @ 1690$ $RM\ (2000 + 800) - (200 + 500 + 250 + 490 + 250)$ Ya Aliran tunai positif $RM\ 1110$ kerana pendapatan melebihi perbelanjaan</p>	
<p>3. Simpanan $\frac{15}{100} \times 5600 @ 840$ Aliran tunai (Pendapatan – Pembelanjaan-simpanan) $(5400 + 200) - (1220 + 800 + 300 + 500) = 840$ Aliran tunai positif Puan Rosmiza ialah $RM\ 1940$ kerana pendapatan melebihi perbelanjaan</p>	
<p>4. (a) $\frac{100000}{5 \times 12}$ $= 1666.67$</p>	<p>(b) $\frac{1666.67}{20\ 000 - 5000} \times 100$ Ya. Kerana mereka boleh membayar wang pendahuluan simpanan kerana hanya 11% daripada pendapatan @ tidak membebankan kerana perbelanjaan tidak melebihi pendapatan @ apa-apa jawapan yang munasabah</p>
<p>5. (a) X- $RM\ 480$ Y- $RM\ 1000$ (b) En Hisyam perlu mengurangkan $RM\ 1035$ daripada belanja rumah, bil utility dan simpanan tabung haji @ apa-apa jawapan yang setara</p>	
<p>6. (a) Aliran tunai (Pendapatan – Pembelanjaan) $RM\ (4500 + 750) - (750 + 950 + 100 + 250 + 88 + 250)$ $RM\ 2462$</p> <p>(b) Jumlah pinjaman (Harga Beli – Pendahuluan) $RM\ 48\ 000 - 10\ 000 = RM\ 38\ 000$</p> <p>Jumlah bayaran balik (Faedah + pinjaman) $38000 \times \frac{4}{100} \times 9 + 38000 = 51680$</p> <p>Bayaran ansuran bulanan $\frac{51680}{9 \times 12} = 418.2$</p> <p>Pn Laili mampu membayar ansuran bulanan kerana dia mempunyai aliran tunai positif iaitu $RM\ 2462 @$ apa-apa jawapan yang setara</p>	

7. (a)
 $P = 4700 - 300 = 4400$
 $Q = 1000 + 350 + 800 = 2150$
 $R = 4400 - 2505 - 2150 = -255$

(b) Aliran tunai Cik Maisarah ialah - RM 255
 Tidak cekap
 Pembelanjaan melebihi pendapatan

(c) i) Kurangkan perbelanjaan tidak tetap seperti kurangkan bil utiliti atau menjimatkan belian barang dapur
 ii) Tambah sumber pendapatan melalui kerja lebih masa atau pekerjaan sampingan.

8. (a)

Pendapatan & Perbelanjaan	RM
Pendapatan bersih	4800
Pendapatan pasif	1500
Jumlah Pendapatan Bulanan	6300
Simpanan tetap	$\frac{25}{100} \times 5300 = 1325$
Dana kecemasan	300
Baki Pendapatan	4675
Perbelanjaan Tetap Bulanan	$750 + 200 = 950$
Perbelanjaan tidak tetap bulanan	$170 + 130 + 88 + 1300 + 150 + 800 = 2638$
Jumlah perbelanjaan tetap bulanan	3588
Pendapatan Lebihan	1087

Mana-mana 2 jawapan yang betul diberi 1 Markah

(b) Metod secara ansuran
 $\frac{375}{1087} \times 100 = 34.49\%$
 Membayar secara ansuran tidak membebaskan kerana hanya 34.49% daripada lebihan pendapatan @
 Pendapatan lebihan tidak mencukupi untuk membeli secara tunai
 @ mana-mana jawapan yang relevan

9. (a) $\frac{15}{100} \times (3200 + 350)$
532.50
- (b) Aliran tunai (Pendapatan bersih- Pembelanjaan)
 $(3550 - 532.50) - (1350 + 300)$
RM1367.50
Aliran tunai positif RM1367.50 kerana jumlah pendapatan melebihi perbelanjaan
- (c) Bank M (Jumlah pinjaman yang perlu dibayar setiap bulan)
 $RM24000 + 24000 \times \frac{4.2}{100} \times 7$
RM 31056
- $$\frac{31056}{3 \times 12}$$
- RM862.67
- Bank N
 $RM24000 + 24000 \times \frac{5.5}{100} \times 7$
RM 33240
- $$\frac{33240}{7 \times 12}$$
- RM 395.71
- Bank N sesuai dipilih kerana Pn Maria tidak akan terbeban dengan pinjaman yang dibuatnya setiap bulan @
Jumlah bayaran bulanan bagi pinjaman Bank M melebihi daripada jumlah simpanan tetapnya @
terima jawapan yang munasabah

10. (a) i) RM 3800+ RM 1100
RM4900
ii) RM700
iii) RM560+RM580+180
RM 1320
iv) RM500+RM120+RM100+RM 250
RM970
- (b) Simpanan
 $\frac{10}{100} \times (3800 + 1100 + 700)$
RM560
- Aliran tunai (Pendapatan bersih – pendapatan)
 $(RM3800+RM1100+RM700) - RM560 - RM300 - (RM 1320+RM970)$
RM 2450
Aliran Tunai En Hamid positif iaitu pendapatan melebihi perbelanjaan
- (c) $RM 20\,000 \left(1 + \frac{0.06}{3}\right)^{(3)(3)}$
RM 23 901.85

11	UBAHAN	
1. i) $P \propto \sqrt{Q}$ $P = k\sqrt{Q}$ $2 = k\sqrt{36}$ $k = \frac{1}{3}$ $P = \frac{1}{3}\sqrt{Q}$ ii) $P = \frac{1}{3}\sqrt{Q}$ $5 = \frac{1}{3}\sqrt{Q}$ $Q = 225$	2. $G \propto h^3$ $G = 3h^3$ $G = kh^3$ $192 = 3h^3$ $24 = k(2)^3$ $h = 4$ $k = 3$ $G = 3h^3$	3. $y \propto x$ $y = kx$ $60 = k(4)$ $k = 15$ $y = 15x$ $y = 15x$ $96 = 15x$ $x = 6.4$
4. $L \propto x^2$ $L = 4x^2$ $L = kx^2$ $L = 4(8)^2$ $100 = k(5)^2$ $L = 256$ $k = 4$ $L = 4x^2$	5. i) $M \propto \frac{1}{\sqrt{N}}$ $M = \frac{k}{\sqrt{N}}$ $5 = \frac{k}{\sqrt{16}}$ $k = 20$ $M = \frac{20}{\sqrt{N}}$ ii) $M = \frac{k}{\sqrt{N}}$ $60 = \frac{20}{\sqrt{N}}$ $N = \frac{1}{9}$	6. $y \propto \frac{1}{x^2}$ $y = \frac{4}{3x^2}$ $y = \frac{k}{x^2}$ $3 = \frac{4}{3w^2}$ $\frac{1}{3} = \frac{k}{(2)^2}$ $w = \frac{2}{3}$ $k = \frac{4}{3}$ $y = \frac{4}{3x^2}$
7. $f \propto \frac{1}{d}$ $f = \frac{420}{d}$ $f = \frac{k}{d}$ $7.5 = \frac{420}{d}$ $8.4 = \frac{k}{50}$ $d = 56$ $k = 420$ $f = \frac{420}{d}$	8. $r \propto \frac{1}{\sqrt{h}}$ $r = \frac{45}{\sqrt{h}}$ $r = \frac{k}{\sqrt{h}}$ $x = \frac{45}{\sqrt{25}}$ $15 = \frac{k}{\sqrt{9}}$ $x = 9$ $k = 45$ $r = \frac{45}{\sqrt{h}}$	9. i) $p \propto \frac{q}{\sqrt[3]{r}}$ $p = \frac{kq}{\sqrt[3]{r}}$ $9 = \frac{k(3)}{\sqrt[3]{8}}$ $k = 6$ $p = \frac{6q}{\sqrt[3]{r}}$ ii) $p = \frac{6q}{\sqrt[3]{r}}$ $p = \frac{6(10)}{\sqrt[3]{64}}$ $p = 15$
10. $Z \propto \frac{1}{x\sqrt{y}}$ $Z = \frac{54}{x\sqrt{y}}$ $Z = \frac{k}{x\sqrt{y}}$ $12 = \frac{54}{(\frac{1}{2})\sqrt{m}}$ $9 = \frac{k}{3\sqrt{4}}$ $m = 81$ $k = 54$ $Z = \frac{54}{x\sqrt{y}}$	11. $s \propto at^2$ $s = \frac{1}{2}at^2$ $s = kat^2$ $125 = k(10)(5)^2$ $294 = \frac{1}{2}(12)t^2$ $k = \frac{1}{2}$ $t = 7$ $s = \frac{1}{2}at^2$	12. $n \propto \frac{1}{pl}$ $n = \frac{4000}{pl}$ $n = \frac{k}{pl}$ $50 = \frac{4000}{(16)l}$ $100 = \frac{k}{(8)(5)}$ $l = 8$ $k = 4000$ $n = \frac{4000}{pl}$

12

MATRIKS

$$1.(a) -\frac{1}{3} \begin{pmatrix} 6 & -3 \\ -5 & 2 \end{pmatrix} @ \begin{pmatrix} -2 & 1 \\ 5 & -2 \\ 3 & -3 \end{pmatrix}$$

$$(b) \begin{pmatrix} 2 & 3 \\ 5 & 6 \end{pmatrix} \begin{pmatrix} x \\ y \end{pmatrix} = \begin{pmatrix} 1 \\ 2 \end{pmatrix}$$

$$\begin{pmatrix} x \\ y \end{pmatrix} = \frac{1}{2(6)-3(5)} \begin{pmatrix} 6 & -3 \\ -5 & 2 \end{pmatrix} \begin{pmatrix} 1 \\ -2 \end{pmatrix}$$

$$x = -4, y = 3$$

$$2.(a) \begin{pmatrix} -\frac{1}{2} & 1 \\ -\frac{3}{2} & 2 \end{pmatrix} = \begin{pmatrix} u & 1 \\ -\frac{3}{2} & v \end{pmatrix}$$

$$u = -\frac{1}{2}, v = -\frac{3}{2}$$

$$(b) \begin{pmatrix} 4 & -2 \\ 3 & -1 \end{pmatrix} \begin{pmatrix} x \\ y \end{pmatrix} = \begin{pmatrix} 1 \\ 3 \end{pmatrix}$$

$$\begin{pmatrix} x \\ y \end{pmatrix} = \frac{1}{(4)(-1)-(-2)(3)} \begin{pmatrix} -1 & 2 \\ -3 & 4 \end{pmatrix} \begin{pmatrix} 1 \\ 3 \end{pmatrix}$$

$$x = \frac{5}{2}, y = \frac{9}{2}$$

$$3 (a) 7l + 9d = 73$$

$$13l + 11d = 107$$

$$(b) \begin{pmatrix} 7 & 9 \\ 13 & 11 \end{pmatrix} \begin{pmatrix} l \\ d \end{pmatrix} = \begin{pmatrix} 73 \\ 107 \end{pmatrix}$$

$$\begin{pmatrix} l \\ d \end{pmatrix} = \frac{1}{(7)(11)-(9)(13)} \begin{pmatrix} 11 & -9 \\ -13 & 7 \end{pmatrix} \begin{pmatrix} 73 \\ 107 \end{pmatrix}$$

$$\begin{pmatrix} l \\ d \end{pmatrix} = \begin{pmatrix} 4 \\ 5 \end{pmatrix}$$

Nasi lemak = RM 4

$$4 (a) d + k = 80$$

$$16d + 10k = 1100$$

$$(b) \begin{pmatrix} 1 & 1 \\ 16 & 10 \end{pmatrix} \begin{pmatrix} d \\ k \end{pmatrix} = \begin{pmatrix} 80 \\ 1100 \end{pmatrix}$$

$$\begin{pmatrix} d \\ k \end{pmatrix} = \frac{1}{(1)(10)-(16)(1)} \begin{pmatrix} 10 & -1 \\ -16 & 1 \end{pmatrix} \begin{pmatrix} 80 \\ 1100 \end{pmatrix}$$

$$d = \text{RM } 50, k = \text{RM } 30$$

$$5(a) m = 3, n = -2$$

$$(b) \begin{pmatrix} x \\ y \end{pmatrix} = \frac{1}{10} \begin{pmatrix} -2 & 3 \\ -4 & 1 \end{pmatrix} \begin{pmatrix} 5 \\ 10 \end{pmatrix}$$

$$x = 2, y = -1$$

$$6(a) x = -\frac{3}{2}$$

$$(b) 30x + 50y = 2190$$

$$50x + 49y = 2220$$

$$\begin{pmatrix} 30 & 50 \\ 50 & 40 \end{pmatrix} \begin{pmatrix} x \\ y \end{pmatrix} = \begin{pmatrix} 2190 \\ 2220 \end{pmatrix}$$

$$\begin{pmatrix} x \\ y \end{pmatrix} = \frac{1}{30(40)-(50)(50)} \begin{pmatrix} 40 & -50 \\ -50 & 30 \end{pmatrix} \begin{pmatrix} 2190 \\ 2220 \end{pmatrix}$$

$$x = \text{RM } 18$$

$$y = \text{RM } 33$$

$$7(a) \quad m = -\frac{1}{10}$$

$$n = -2$$

$$(b) \quad \begin{pmatrix} 3 & 4 \\ 1 & -2 \end{pmatrix} \begin{pmatrix} x \\ y \end{pmatrix} = \begin{pmatrix} 1 \\ 7 \end{pmatrix}$$

$$\begin{pmatrix} x \\ y \end{pmatrix} = \frac{1}{3(-2) - 4(1)} \begin{pmatrix} -2 & -4 \\ -1 & 3 \end{pmatrix} \begin{pmatrix} 1 \\ 7 \end{pmatrix}$$

$$x = 3$$

$$y = -2$$

$$8(a) \quad m = -\frac{1}{2}$$

$$n = 4$$

$$(b) \quad \begin{pmatrix} 6 & -4 \\ 7 & -5 \end{pmatrix} \begin{pmatrix} v \\ w \end{pmatrix} = \begin{pmatrix} 4 \\ 7 \end{pmatrix}$$

$$\begin{pmatrix} v \\ w \end{pmatrix} = \frac{1}{6(-5) - (-4)(7)} \begin{pmatrix} -5 & 4 \\ -7 & 6 \end{pmatrix} \begin{pmatrix} 4 \\ 7 \end{pmatrix}$$

$$x = -4$$

$$y = -7$$

$$9 \quad 12t + 35k = 98700$$

$$7t + 10k = 33300$$

$$\begin{pmatrix} 12 & 35 \\ 7 & 10 \end{pmatrix} \begin{pmatrix} t \\ k \end{pmatrix} = \begin{pmatrix} 98700 \\ 33000 \end{pmatrix}$$

$$\begin{pmatrix} t \\ k \end{pmatrix} = \frac{1}{12(10) - (35)(7)} \begin{pmatrix} 10 & -35 \\ -7 & 12 \end{pmatrix} \begin{pmatrix} 98700 \\ 33000 \end{pmatrix}$$

$$t = \text{RM}1344$$

$$k = \text{RM}2359.20$$

$$10(a) \quad i + b = 90$$

$$2i + 4b = 252$$

$$(b) \quad \begin{pmatrix} 1 & 1 \\ 2 & 4 \end{pmatrix} \begin{pmatrix} i \\ b \end{pmatrix} = \begin{pmatrix} 90 \\ 252 \end{pmatrix}$$

$$\begin{pmatrix} i \\ b \end{pmatrix} = \frac{1}{1(4) - 1(2)} \begin{pmatrix} 4 & -1 \\ -2 & 1 \end{pmatrix} \begin{pmatrix} 90 \\ 252 \end{pmatrix}$$

$$\begin{pmatrix} i \\ b \end{pmatrix} = \begin{pmatrix} 54 \\ 36 \end{pmatrix}$$

$$itik = 54, \quad biri - biri = 36$$

$$11 \quad 4x + 3y = 27.50$$

$$3x + 5y = 27.50$$

$$\begin{pmatrix} 4 & 3 \\ 3 & 5 \end{pmatrix} \begin{pmatrix} x \\ y \end{pmatrix} = \begin{pmatrix} 27.50 \\ 27.50 \end{pmatrix}$$

$$\begin{pmatrix} x \\ y \end{pmatrix} = \frac{1}{4(5) - (3)(3)} \begin{pmatrix} 5 & -3 \\ -3 & 4 \end{pmatrix} \begin{pmatrix} 27.50 \\ 27.50 \end{pmatrix}$$

$$\begin{pmatrix} x \\ y \end{pmatrix} = \begin{pmatrix} 5 \\ 2.5 \end{pmatrix}$$

$$x = \text{RM}5$$

$$y = \text{RM}2.50$$

$$12 \quad 4r + 6k = 38$$

$$3r + 5k = 30$$

$$\begin{pmatrix} 4 & 6 \\ 3 & 5 \end{pmatrix} \begin{pmatrix} r \\ k \end{pmatrix} = \begin{pmatrix} 38 \\ 30 \end{pmatrix}$$

$$\begin{pmatrix} r \\ k \end{pmatrix} = \frac{1}{4(5) - (3)(6)} \begin{pmatrix} 5 & -6 \\ -3 & 4 \end{pmatrix} \begin{pmatrix} 38 \\ 30 \end{pmatrix}$$

$$\begin{pmatrix} r \\ k \end{pmatrix} = \begin{pmatrix} 5 \\ 3 \end{pmatrix}$$

$$r = \text{RM}5$$

$$k = \text{RM}3$$

13

MATEMATIK PENGGUNA: INSURANS

8. (a) pemegang polisi (d) Risiko
 (b) Prinsip indemniti (e) pampasan
 (c) deduktibel; ko-insurans (f) premium

9. (a) Insurans perubatan dan kesihatan
 (b) (i) Insurans hospital dan pembedahan
 (ii) Insurans pendapatan hospital

10. Kos perubatan selepas deduktibel = $12\,500 - 300$
 $= 12\,200$
 Bayaran yang perlu ditanggung oleh Adira =
 $\left(\frac{25}{100} \times 12\,200\right) + 300$
 $= \text{RM } 3\,350$

Bayaran pampasan yang diterima = $\left(\frac{75}{100} \times 12\,200\right)$
 $= \text{RM } 9\,150$

11.
 $41\,800 = \left(\frac{x}{500\,000} \times 52\,000\right) - 500$
 $x = \text{RM } 450\,000$

12. Jumlah yang ditanggung oleh Marissa = RM 6 900

$$\left(\frac{y}{100} \times 64\,000 + 500\right) = 6\,900$$

$$y = 10$$

$$x = 100 - 10$$

$$= 90$$

$$\therefore x = 90, \quad y = 10$$

13.

Perkara	Dilindungi / Tidak dilindungi
a. Kerosakan kereta En Maarof	Dilindungi
b. Kerosakan kereta Pn Aini	Dilindungi
c. Kecederaan En Maarof	Tidak dilindungi
d. Kecederaan En Sufian	Tidak dilindungi
e. Kecederaan Pn Aini	Dilindungi

14. (a) *Semakin panjang tempoh perjalanan semakin tinggi premium insurans perjalanan.*
 (b) *Tempoh perjalanan yang lebih panjang meningkatkan lagi kebarangkalian berlaku kerugian pada pemegang polisi semasa berada di luar negara.*
 (c) *En Hamid perlu membeli insurans perjalanan premium tahunan kerana ini lebih menjimatkan daripada membeli insurans bagi tempoh 13-18 hari setiap kali perjalanan.*

15. (a) $\frac{180\,000}{1\,000} \times \text{RM } 2.52 = \text{RM } 453.60$
 (b) Premium asas tahunan =
 $\frac{300\,000}{1\,000} \times \text{RM } 1.56 = \text{RM } 468.00$
 Jumlah perlindungan penyakit kritikal =
 $\frac{25}{100} \times \text{RM } 300\,000 = \text{RM } 75\,000$
 Premium tambahan tahunan penyakit kritikal =
 $\frac{75\,000}{1\,000} \times \text{RM } 1.65 = \text{RM } 123.75$
 Premium tahunan yang perlu dibayar oleh Pn Khatijah = $\text{RM } 468.00 + \text{RM } 123.75 = \text{RM } 591.75$

16. a) Kos perubatan selepas deduktibel = $38\,000 - 5\,000$
 $= 33\,000$
 Bayaran yang ditanggung Encik Siva = $\left(\frac{30}{100} \times 33\,000\right) + 5\,000$
 $= \text{RM } 14\,900$
 Bayaran yang ditanggung oleh syarikat insurans = $38\,000 - 14\,900$
 $= 23\,100$
 b) i-Bayaran yang ditanggung Puan Mimi = $123\,750 - 95\,000$
 $= \text{RM } 28\,750$
 ii-Bayaran oleh syarikat insurans : Bayaran yang ditanggung Puan Mimi selepas deduktibel
 $95\,000 : 28\,750 - 5\,000$
 $95\,000 : 23\,750$
 $4 : 1$
 $4 \times 20 : 1 \times 20$
 $80 : 20$

17. (a) polisi komprehensif

(i) RM 1 000 yang pertama	RM 266.50
(ii) RM 20.30 X <u>249.00</u> (Setiap RM 1 000 baki)	RM 5 054.70
(iii) Premium asas = (i) + (ii)	RM 5 321.20
(iv) NCD 55%	RM 2 926.66
(v) Premium kasar = (iii) – (iv)	RM 2 394.54

(b) polisi pihak ketiga, kebakaran dan kecurian

(i) Premium asas = 0.75 X <u>RM 5 321.20</u>	RM 3 990.90
(ii) NCD 55%	RM 2 195.00
(iii) Premium kasar = (i) – (ii)	RM 1 795.91

(c) polisi pihak ketiga

(i) Premium asas	RM 93.60
(ii) NCD 55%	RM 51.48
(iii) Premium kasar	RM 42.12

14

MATEMATIK PENGGUNA:PERCUKAIAN

1. Pendapatan Bercukai:

= Jumlah pendapatan – Pengecualian cukai – Pelepasan cukai
 96356- 52000—(9000+6250+3000)
 72906

2. Pendapatan Bercukai:

= Jumlah pendapatan – Pengecualian cukai – Pelepasan cukai
 = 48 065 – 300 – 9 000 – 2 300 – 1 500 atau 34965 atau setara

RM 20 000 pertama → Cukai RM 150

Cukai atas baki berikutnya:

(34965 – 20 000) × 3% atau 448.95 atau setara

Rebat yang layak kerana pendapatan bercukai kurang atau sama dengan RM35 000 ialah RM400

Jumlah cukai yang perlu di bayar

= 150 + 448.95 – 400

= 198.95

3. (a) Pengecualian cukai

RM1450+RM 500

RM 1950

Pelepasan cukai

9 000 + 1500 + 1000 +6 250+ 3 000+ 3000

23 750

Pendapatan bercukai

RM (75311-1950-23750)

RM 49 611

(b) Cukai Pendapatan

35000 yang pertama → RM600

Cukai atas baki berikutnya:

(49611 – 35 000) × 8% atau 1168.88 atau setara

Jumlah cukai yang perlu dibayar

RM600 + RM 1168.88

RM1768.88

(c) PCB yang telah dibayar tahun lepas

RM 300x 12= RM 3600

Jumlah terlebih bayar ialah

RM3600-1768.88

Ya, Encik Rahman mempunyai baki terlebih bayar iaitu sebanyak

RM 1831.12

<p>4. (a) Cukai perkhidmatan</p> $4(26) + 2(40) + 18 + 35 + 6(6.50) = 276$ $\frac{6}{100} \times 276 = 16.56$ <p>Jumlah yang perlu dibayar $276 + 16.56$ 292.56</p> <p>(b) i) Gerai itu tidak menjana hasil melebihi RM 1 500 000 setahun. ii) Harga asal + = harga belian $x + 0.06x = \text{RM } 12.60$ $x =$</p> <p>Harga asal kopi ialah RM 11.89</p>
<p>5. Honda Civic 1.8S (Saiz enjin 1977cc)</p> <p>Kadar asas = RM200 (Bagi 1600cc yang pertama) Kadar progresif = RM79.60 $1799\text{cc} - 1600\text{cc} = 199\text{cc}$ $199\text{cc} \times \text{RM}0.40 = \text{RM}79.60$</p> <p>Maka jumlah cukai jalan Afwan bagi keretanya = RM279.60</p>
<p>6. Nilai tahunan = $\text{RM}4000 \times 12 = \text{RM}48000$ Cukai pintu = $\text{RM}48000 \times 4\%$ = RM1920</p>
<p>7. Cukai tanah Bandar $\text{RM}0.035 \times 2500 \text{ kps} = \text{RM}87.50$</p> <p>Cukai tanah di luar Bandar $\text{RM}0.015 \times 665 \text{ kps} = \text{RM}9.98$</p> <p>Jumlah cukai tanah bagi kedua-dua tanah hak miliknya ialah $\text{RM}87.50 + \text{RM}9.98 = \text{RM}97.48$ = RM97.50 (Bundar kpd sen terhampir)</p>
<p>8. Honda Accord 2.4 (Kapasiti enjin 2356cc)</p> <p>Kadar asas = RM380.00 Kadar Progresif $(2356\text{cc} - 2000\text{cc}) \times \text{RM}1.00 = \text{RM}356.00$ Jumlah RM736.00</p> <p>Proton Inspira 1.8 (Kapasiti enjin 1798cc)</p> <p>Kadar asas = RM200.00 Kadar Progresif $(1798\text{cc} - 1600\text{cc}) \times \text{RM}0.40 = \text{RM } 79.20$ Jumlah = RM279.20</p> <p>Maka cukai jalan bagi kedua-dua keretanya ialah RM1 015.20</p>
<p>9. Kereta</p> <p>Kadar asas = RM380.00 Kadar Progresif $(2487\text{cc} - 2000\text{cc}) \times \text{RM}1 = \text{RM}487.00$ Cukai jalan kereta = RM867.00</p> <p>Cukai jalan motosikal = RM 50.00 Jumlah cukai jalan kenderaan Hazim = RM917.00</p>

15 KEKONGRUENAN, PEMBESARAN DAN GABUNGAN TRANSFORMASI

<p>1. (a) (i) $(-3, 5)$ (ii) $(2, -1)$ (b) (i) Putaran 90° lawan arah jam pada pusat B (ii) Pembesaran pada pusat F dengan faktor skala 3 (c) 336</p>	<p>2. (a) (i) $(0, -2)$ (ii) $(-1, 3)$ (b) (i) Pembesaran pada pusat A / pusat $(2, 1)$ dengan faktor skala $\frac{3}{5}$ (ii) Pantulan pada $x = 5$ (c) 21.6</p>
<p>3. (a) (i) Putaran 90° lawan arah jam pada pusat $(2, 5)$ atau Putaran 90° arah jam pada pusat $(4, 11)$ (ii) (a) $(0, 7)$ (b) $(0, 8)$ jika jawapan di (a) Putaran 90° lawan arah jam pada pusat $(2, 5)$ $(1, 11)$ jika jawapan di (a) Putaran 90° arah jam pada pusat $(4, 11)$ (b) (i) Pembesaran pada titik $(8, 7)$ dengan faktor skala $-\frac{1}{2}$ (ii) Pantulan pada $y = 6$ (c) 20</p>	<p>4. (a) (i) $(1, 1)$ (ii) $(7, -3)$ (iii) $(-2, -1)$ (b) (i) (a) Putaran 90° arah jam pada pusat $(0, -1)$ (b) Pembesaran pada pusat P / pusat $(2, 1)$ dengan faktor skala 2. (ii) 40.8</p>
<p>5. (a) (i) $(-4, 1)$ (ii) $(0, 1)$ (b) (i) Pembesaran pada pusat $(8, 5)$ dengan faktor skala 3 (ii) Putaran 90° lawan arah jam pada pusat $(5, 8)$ atau Putaran 90° arah jam pada pusat $(4, 3)$ (c) 160</p>	<p>6. (a) (i) $(2, 0)$ (ii) $(4, 3)$ (b) (i) Pembesaran pada pusat A / pada pusat $(2, 9)$ dengan faktor skala 2 (ii) Pantulan pada $y = 9$ (c) 12</p>
<p>7. (a) (i) $(2, 3)$ (ii) $(-3, 4)$ (b) (i) M = Pembesaran pada pusat $(4, 2)$ dengan faktor skala 3 N = Pantulan pada $y = -x + 6$ (ii) 200</p>	<p>8. (a) (i) $(-3, -3)$ (ii) $(-4, 3)$ (iii) $(-3, -5)$ (b) Putaran 150° lawan arah jam pada pusat A atau Pantulan pada garis AD</p>
<p>9. (a) (i) $(4, 1)$ (ii) $(6, -5)$ (iii) $(-2, -2)$ (b) (i) Pantulan pada garis TU (ii) Translasi $\begin{pmatrix} 6 \\ 0 \end{pmatrix}$</p>	<p>10. (a) (i) $(7, 3)$ (ii) $(2, 7)$ (iii) $(2, -4)$ (b) Putaran 180° pada pusat A</p>

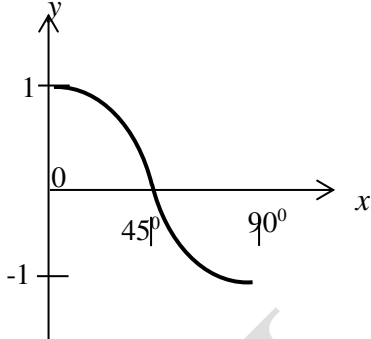
16 NISBAH DAN GRAF FUNGSI TRIGONOMETRI				
1	(a) $-\frac{3}{4}$ (b) 135°	4	(a)	
2	(a) 240° (b) 0.6		(b)	$y = 2\sin 4x$
3	(a) $y = \frac{1}{2} \sin 2x$ (b) 297°	5	(a)	225°
			(b)	$p = 45^\circ, q = 225^\circ$

17 SUKATAN SERAKAN DATA TERKUMPUL				
1. Lengkapkan jadual di bawah.				
Ketinggian (cm)	Had Bawah	Had Atas	Sempadan Bawah	Sempadan Atas
140-144	140	144	139.5	144.5
145-149	145	149	144.5	149.5
150-154	150	154	149.5	154.5
155-159	155	159	154.5	159.5
160-164	160	160	159.5	164.5
165-169	165	169	164.5	169.5
170-174	170	174	169.5	174.5
2.				
Bilangan botol	Kekerapan	Titik Tengah	Kekerapan Longgokan	
20-29	0	24.5	0	
30-39	12	34.5	12	
40 - 49	15	44.5	27	
50 - 59	9	54.5	36	
60 - 69	8	64.5	44	
70 - 79	6	74.5	50	
3.				
(a) <i>Bentuk U</i>				
(b) <i>Bentuk J</i>				
(c) <i>Bentuk J songsang</i>				
(d) <i>Bimod</i>				
(e) <i>Bentuk Loceng</i>				
(f) <i>Bentuk seragam</i>				
(g) <i>Pencong ke kanan</i>				
(h) <i>Pencong ke kiri</i>				

4.

Luas (m ²)	Kekerapan, f	Titik Tengah, x	fx	x^2	fx^2
10 - 14	3	12	36	144	432
15 - 19	5	17	85	289	1445
20 - 24	8	22	176	484	3872
25 - 29	2	27	54	729	1458
30 - 34	2	32	64	1024	2048
	$\Sigma f = 20$		$\Sigma fx = 415$		$\Sigma fx^2 = 9255$

$$\text{Min, } \bar{x} = \frac{415}{20} = 20.75 \quad \text{Varians, } \sigma^2 = \frac{9255}{20} - 20.75^2 = 32.19 \quad \text{Sisihan piawai, } \sigma = \sqrt{32.19} = 5.67$$

5. (a) Kelas Zumar : *Bentuk Loceng*
Kelas Furqan : *Bentuk J*

(b) *Markah kelas Zumar terserak lebih luas berbanding markah kelas Furqan.*

(c) *Pelajar Kelas Furqan mempunyai prestasi yang lebih cemerlang kerana lebih ramai pelajar mendapat markah yang tinggi.*

6. **Kelas Anggerik**

Min = 6.1 Sisihan piawai = 2.58

Kelas Teratai

Min = 5.1 Sisihan Piawai = 2.8

Pelajar kelas Anggerik terdiri daripada keluarga yang lebih stabil dari segi pendapatan kerana minnya lebih besar daripada Pelajar Kelas Teratai (6.1 > 5.1) dan sisihan piawainya yang lebih kecil (2.58 < 2.8) menunjukkan keluarga yang lebih stabil dari segi pendapatan.

7. (a) (i) $P_{15} = 69.5$
(ii) $P_{60} = 75$

(b) 83°

(c) 56.67%

8. (a)

Markah	Kekerapan, f	Titik Tengah, x	fx	x^2	fx^2
20 - 24	0	22	0	484	0
25 - 29	5	27	135	729	3 645
30 - 34	7	32	224	1 024	7 168
35 - 39	8	37	296	1 369	10 952
40 - 44	6	42	252	1 764	10 584
45 - 49	4	47	188	2 209	8 836
	30		1 095		41 185

(b) min, $x = 36.5$

Sisihan piawai, $\sigma = 6.37$

9. (a)

Tinggi (cm)	Kekerapan	Kekerapan Longgokan	Sempadan Atas
135 – 139	0	0	139.5
140 – 144	5	5	144.5
145 – 149	11	16	149.5
150 – 154	18	34	154.5
155 – 159	22	56	159.5
160 – 164	12	68	164.5
165 – 169	2	70	169.5

(b)

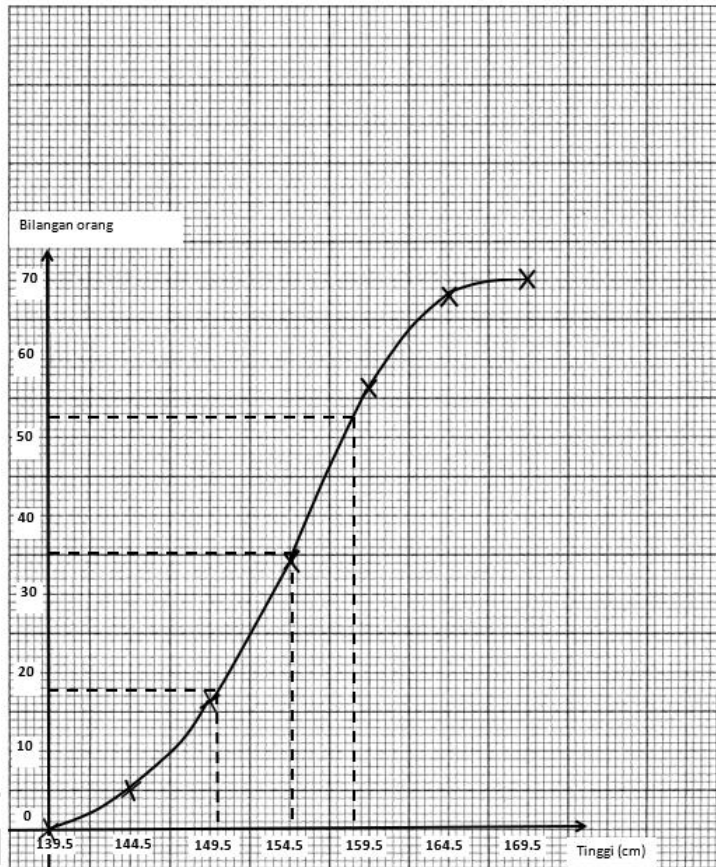

(c)

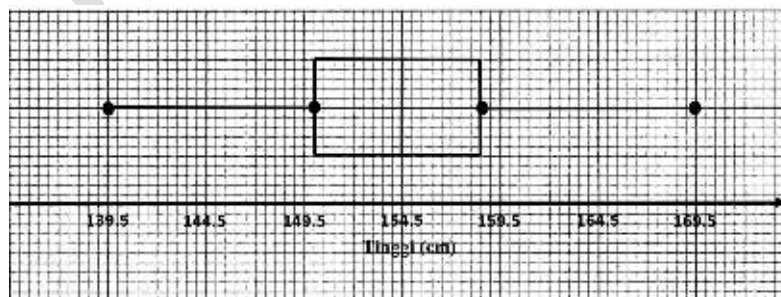

Median = 154.5

Q1 = 150

Q3 = 158.5

Julat antara kuartil = 8.5

Nilai minimum = 139.5

Nilai maksimum = 169.5

10. (a)

Nilai Wang (RM)	Titik Tengah	Kekerapan	Kekerapan Longgokan
11 – 15	13	1	1
16 – 20	18	4	5
21 – 25	23	6	11
26 – 30	28	10	21
31 – 35	33	9	30
36 – 40	38	8	38
41 – 45	43	2	40

(b) Varians, $\sigma^2 = 53.19$
 Sisihan piawai, $\sigma = 7.29$

(c)

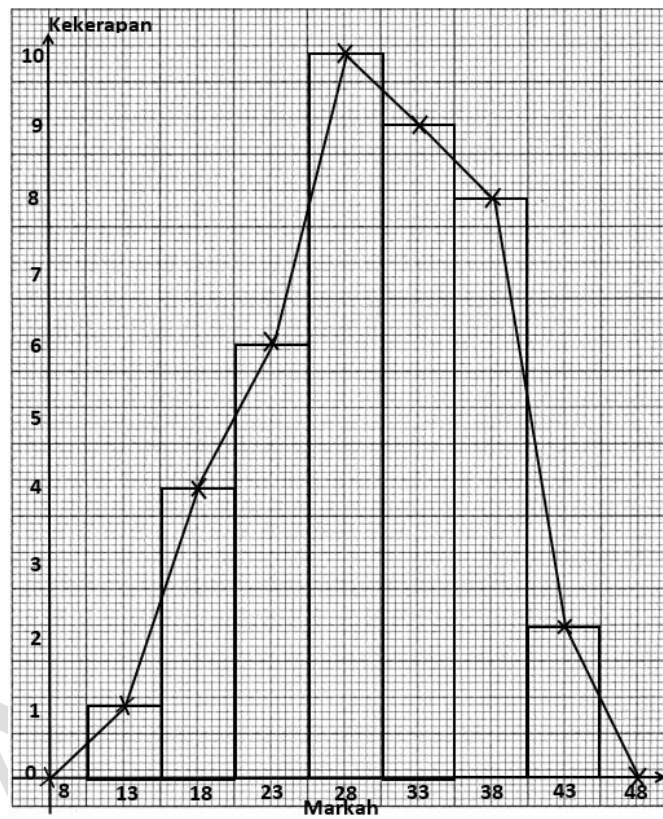

18

PEMODELAN MATEMATIK

1.

Persoalan	Andaian	Pembolehubah
(a) Jumlah tol yang diterima daripada 10 buah kenderaan ialah RM 41.00. Berapakah jumlah tol yang diterima daripada 25 buah kenderaan yang melalui lebuh raya yang sama.	-Semua kenderaan tersebut adalah sama -Kadar tol yang dikenakan adalah bagi setiap kenderaan	-Bilangan kenderaan -Jumlah tol yang diterima
(b) Syahida membeli 5 bungkus nasi lemak yang berharga RM 20.00 di sebuah gerai makanan. Berapakah harga yang perlu dibayar oleh Syahida jika dia membeli 8 bungkus nasi lemak.	-Harga bagi sebungkus nasi lemak -Jenis lauk adalah sama bagi setiap bungkus nasi lemak	-Bilangan nasi lemak yang dibeli -Harga yang perlu dibayar

2.

Katakan Q mewakili jarak perjalanan dan P mewakili jumlah petrol yang diperlukan.
 P berubah secara langsung dengan Q , maka $P = kQ$ dengan keadaan k ialah pemalar.

Gantikan $P = 48$ dan $Q = 432$, ke dalam $P = kQ$

$$48 = k(432)$$

$$k = \frac{48}{432} = \frac{1}{9}$$

$$\text{maka, } P = \frac{1}{9}Q$$

Hubungan antara jumlah petrol dengan jarak perjalanan

$$\begin{aligned} \text{apabila } Q = 207, P &= \frac{1}{9}(207) \\ &= 23 \text{ liter} \end{aligned}$$

3.

(a) Andaikan x ialah bilangan hari En Arif bercuti di Kuantan
 y ialah Caj perkhidmatan termasuk sewa yang perlu dibayar untuk tempat penginapan

(b) y berubah secara langsung dengan x , maka $y = kx$ dengan keadaan k ialah pemalar perkadaran.

Gantikan $y = 450$ dan $x = 5$, ke dalam $y = kx$

$$450 = k(5)$$

$$k = 90$$

$$\text{maka, } y = 90x$$

Persamaan model Linear

$$\text{Caj } y = 90(7)$$

$$= 630$$

(c) Tidak, $y = 90x$ bermaksud En Arif perlu membayar RM 90 sehari. Bayaran ini tidak untuk semua situasi, mungkin En Arif menginap bilik lebih murah atau lebih mahal daripada RM 90

4.

$$(a) \quad M(t) = 0.25t$$

$$(b) \quad N(t) = 30 + 0.15t$$

(c) Pelan pascabayar lebih berbaloi daripada pelan prabayar

$$M(t) > N(t)$$

$$0.25t > 30 + 0.15t$$

$$t > 300$$

Panggilan minimum ialah 300 minit

5.

(a) Jumlah hasil jualan (K) = harga seunit (h) X Bil unit dijual

$$h = -25p + 400$$

$$K(h) = \left(-\frac{1}{25}h + 16\right)(h)$$

$$p = -\frac{1}{25}h + 16$$

$$= -\frac{1}{25}h^2 + 16h$$

$$(b) \quad K(h) = -\frac{1}{25}h^2 + 16h$$

$$\begin{aligned} K(40) &= -\frac{1}{25}(40)^2 + 16(40) \\ &= 576 \end{aligned}$$

(c) Jualan maksimum pada paksi simetri

$$K(h) = ah^2 + bh + c$$

$$h = \frac{-16}{2\left(-\frac{1}{25}\right)} = 200$$

$$h = -\frac{b}{2a} \quad k(h) = -\frac{1}{25}h^2 + 16h$$

$$a = -\frac{1}{25} \quad b = 16$$

$$\begin{aligned} K(200) &= -\frac{1}{25}(200)^2 + 16(200) \\ &= 1600 \end{aligned}$$

$$(d) \quad p = -\frac{1}{25}h + 16$$

$$p = -\frac{1}{25}(200) + 16$$

$$= RM 8$$

6.

(a)

Tahun	1990	2000	2010
Bilangan Tahun, t	0	10	20
Nilai pasaran $k(t)$	RM72 000	RM87 000	RM 142 000

$$k(t) = at^2 + bt + c$$

Persamaan 1	Persamaan 2	Persamaan 3
$k = 72\ 000$ $t = 0$	$k = 87\ 000$ $t = 10$	$k = 142\ 000$ $t = 20$
$72000 = a(0)^2 + b(0) + c$ $c = 72000$	$87\ 000 = a(10)^2 + b(10) + c$ $87000 = 100a + 10b + c$	$142\ 000 = a(20)^2 + b(20) + c$ $142000 = 400a + 20b + c$

$$100a + 10b = 15000$$

$$400a + 20b = 70\ 000$$

$$a = 200 \quad b = -500$$

$$\text{maka } k(t) = 200t^2 - 500t + 72000$$

$$(b) \quad k(t) = 200t^2 - 500t + 72000 \quad t = 26$$

$$\begin{aligned} k(26) &= 200(26)^2 - 500(26) + 72000 \\ &= 194200 \end{aligned}$$

$$(c) \quad 299500 = 200t^2 - 500t + 72000$$

$$t = 35 \text{ tahun } 2025$$

7.

Minggu	Pengiraan (km)	Jarak larian (km)
1	$30 + 30 \times 0.2 = 30(1 + 0.2)$	$30(1.2)$
2	$30(1.2) + 30(1.2) \times 0.2 = 30(1.2)(1 + 0.2)$	$30(1.2)^2$
3	$30(1.2)^2 + 30(1.2)^2 \times 0.2 = 30(1.2)^2(1 + 0.2)$	$30(1.2)^3$
4	$30(1.2)^3 + 30(1.2)^3 \times 0.2 = 30(1.2)^3(1 + 0.2)$	$30(1.2)^4$

$$H(x) = 30(1.2)^n$$

19

PERSAMAAN LINEAR SERENTAK

1. $p = 3, q = 4$

2. $v = 10, w = -18$

3. Nombor besar ialah 47 dan nombor kecil ialah 35

4. Bilangan guli Ali ialah 135

Bilangan guli Mansor ialah 105

5. Harga sekilogram betik ialah RM 3.50

Harga sekilogram tembikai ialah RM 2.50

Duku = RM6, Rambutan = RM5

20		PEPEJAL GEOMETRI	
1	$\frac{1}{3} \times 4 \times 6 + \frac{1}{2} \times (7+4) \times 3 \times 6$ $= 163$	2	$7 \times 10 \times 8 - \frac{1}{4} \times \frac{22}{7} \times \left(\frac{7}{2}\right)^2 \times 10$ $= 463\frac{3}{4}$
3	$\frac{22}{7} \times \left(\frac{9}{2}\right)^2 \times l = \frac{22}{7} \times \left(\frac{9}{2}\right)^2 \times 8 - \frac{1}{2} \times \frac{4}{3} \times \frac{22}{7} \times \left(\frac{9}{2}\right)^3$ $l = 5$ $t = 5 + \frac{9}{2}$ $= 9.5$	4	$6 \times 12 \times 11 = \frac{1}{3} \times \frac{22}{7} \times (r)^2 \times 7$ $r^2 = 108$ $r = 10.39$
5	$\frac{1}{3} \times \left(\frac{22}{7}\right) \times 9^2 \times 14 - \frac{22}{7} \times 3^2 \times 7$ $= 990$	6	$\frac{22}{7} \times 7^2 \times 10 + \frac{1}{3} \times \frac{22}{7} \times 7^2 \times 8$ $= 1950\frac{2}{3}$
7	$15DH - \frac{1}{2} \times \frac{22}{7} \times 2^2 \times DH = 52\frac{2}{9}$ $DH = 6$	8	$\frac{1}{2} \times 5 \times 12 \times 10 + \frac{1}{3} \times \frac{1}{2} \times \frac{22}{7} \times 5^2 \times 13$ $= 470\frac{5}{21}$
9	$\frac{1}{2} \times \frac{22}{7} \times \left(\frac{7}{2}\right)^2 \times 6 + \frac{1}{2} \times BC \times 7 \times 6 = 451\frac{1}{2}$ $BC = 16$	10	$\frac{22}{7} \times \left(\frac{7}{2}\right)^2 \times 6 + \frac{1}{2} (9+12) \times 8 \times AB = 987$ $AD = 9$

21		PERSAMAAN GARIS LURUS	
1. (a) $m = -\frac{4}{3}$ (b) $y = \frac{1}{2}x - 2$ (c) $0 = \frac{1}{2}x - 2$ $x = 4$	2. (a) $y = 3x$ (b) $D = (-1, -3)$		
3. (a) $y = \frac{1}{2}x + 6$ Koordinat $Q = (6, 9)$ (b) $x = 6$	4. (a) $y = -\frac{3}{4}x - 3$, $m = -\frac{3}{4}$ (b) $x = -4$ (c) $RS = 5$ unit		
5. (a) $\frac{k}{3} = \frac{1}{2}$, $k = \frac{3}{2}$ (b) $x = -\frac{14}{3}$	6. (a) $x = 3$ (b) $m = -2$, $y = -2x + 12$ pintasan- $x = 6$		

7. (a) $y = 4$ (b) $y = -3x + 13$ (c) Koordinat $U = (-4, 4)$ $RS = UT = 7$	8. (a) $m = -\frac{1}{3}$ $y = -\frac{1}{3}x + 6$ (b) $0 = -\frac{1}{3}x + 6$ $x = 18$
9. (a) 10 unit (b) $m = \frac{4}{3}$ $9 = \frac{4}{3}(9) + c, c = -3$ $y = \frac{4}{3}x - 3$	

22		PERIMETER DAN LUAS BULATAN	
1. (a) 22.38	(b) 21.28	2. (a) 122.73	(b) 81.86
3. (a) 53.67	(b) 115.5	4. (a) 64.67	(b) 154
5. (a) 140	(b) 69	6. (a) 53.17 (b) (i) 19.25 (ii) untung beli Premium dengan kelebihan luas 38.5 cm^2	
7. (a) 568	(b) 9.99	8. (a) 243.83	(b) 104.33
9. (a) 198.28	(b) 74.57	10. 31.19	

23		GRAF FUNGSI																									
PRAKTIS 1 a) <table border="1" style="margin-left: 40px;"> <tr> <td>x</td> <td>-1</td> <td>2</td> <td>4</td> </tr> <tr> <td>y</td> <td>1</td> <td>-5</td> <td>11</td> </tr> </table> b) rujuk graf c) i. $y = 5.5$ ii. $x = 2.9, x = -0.9$ d) $y = 4x - 8,$		x	-1	2	4	y	1	-5	11	PRAKTIS 2 (i) garis $y = -10, x = 2.9$ (ii) garis $y = x, x = 1.3$ (iii) garis $y = -5x + 20, x = -2.7$ (iv) garis $y = -5x + 15, x = -2.3,$ $x = 15, x = 2.2$																	
x	-1	2	4																								
y	1	-5	11																								
<u>Kertas 1</u> SOALAN ANEKA PILIHAN <table border="1" style="margin-left: 40px;"> <tr> <td>NO SOALAN</td> <td>1</td> <td>2</td> <td>3</td> <td>4</td> <td>5</td> </tr> <tr> <td>JAWAPAN</td> <td>C</td> <td>B</td> <td>C</td> <td>8</td> <td>8</td> </tr> <tr> <td>NO SOALAN</td> <td>6</td> <td>7</td> <td>8</td> <td>9</td> <td>10</td> </tr> <tr> <td>JAWAPAN</td> <td>C</td> <td>B</td> <td>5</td> <td>C</td> <td>D</td> </tr> </table>				NO SOALAN	1	2	3	4	5	JAWAPAN	C	B	C	8	8	NO SOALAN	6	7	8	9	10	JAWAPAN	C	B	5	C	D
NO SOALAN	1	2	3	4	5																						
JAWAPAN	C	B	C	8	8																						
NO SOALAN	6	7	8	9	10																						
JAWAPAN	C	B	5	C	D																						
<u>Kertas 2</u>																											
Soalan 1 a) <table border="1" style="margin-left: 40px;"> <tr> <td>x</td> <td>-1</td> <td>2</td> <td>4</td> </tr> <tr> <td>y</td> <td>1</td> <td>-5</td> <td>11</td> </tr> </table> b) rujuk graf c) i. $y = 5.5$ ii. $x = 2.9, x = -0.9$ d) $y = 4x - 8, x = 0.4, x = 3.65$		x	-1	2	4	y	1	-5	11	Soalan 2 a) <table border="1" style="margin-left: 40px;"> <tr> <td>x</td> <td>-2</td> <td>3</td> </tr> <tr> <td>y</td> <td>9</td> <td>-6</td> </tr> </table> b) rujuk graf c) $y = 4 - 2x, x = -1.9, x = 3.35$		x	-2	3	y	9	-6										
x	-1	2	4																								
y	1	-5	11																								
x	-2	3																									
y	9	-6																									

Soalan 3

x	-3	0	2
y	-28	5	-3

- b) rujuk graf
 c) i. $y = 3.2$ ii. $x = -1$, $x = 1.7$
 d) $y = 4x - 20$, $x = 2.6$

Soalan 4

x	-2	1	3
y	13	-2	8

- b) rujuk graf
 c) i. $y = 13.5$ ii. $x = 3.65$
 d) $y = 4x + 6$, $x = -0.1$, $x = 3.5$

Soalan 5

x	-2	1	3
y	17	-4	2

- b) rujuk graf
 c) $y = 14$
 d) $y = 11$, $x = -2.75$, $y = -0.6$, $x = 3.45$

Soalan 6

x	-2	1	3
y	30	9	15

- b) rujuk graf
 c) $y = 23$
 d) $y = 28$, $x = -2.35$, $x = -1.2$, $x = 3.55$

Soalan 7

x	-2	3
y	23	-2

- b) rujuk graf
 c) i. $y = -7.5$ ii. $x = -3.7$
 d) $y = 3x + 5$, $x = -3.9$, $x = 0.15$, $x = 3.8$

Soalan 8

x	-2.5	3
y	2.4	-2

- b) rujuk graf
 c) i. $y = -4.65$ ii. $y = -1.85$
 d) $y = -2x + 2$, $x = -1.4$, $x = 2.3$

Soalan 9

x	1.5	3
y	2	1.5

- b) rujuk graf
 c) i. $y = 2.15$ ii. $x = 0.85$
 d) Garis $y = x + 1$, $x = 1.2$

Soalan 10

x	-4	2
y	26	-4

- b) rujuk graf
 c) i. $-2.85 \leq x \leq -2.65$, $3.15 \leq x \leq 3.35$
 ii. $-5.4 \leq y \leq -5.2$
 d) Garis $y = 3x + 9$, Nilai x $-2.35 \leq x \leq -1.15$

Soalan 11

x	-2	2
y	-2	12

- a)
 b) rujuk graf
 c) i. $41.5 \leq y \leq 43.5$
 ii. $-2.7 \leq y \leq -2.6$
 d) Garis $y = 15x$
 Nilai x : $3.6 \leq x \leq 3.8$
 $0.3 \leq x \leq 0.4$

Soalan 12

x	-3	2
y	-2.67	4

- b) rujuk graf
 c) i. $1.5 \leq x \leq 1.7$
 ii. $-3.4 \leq y \leq -3.2$
 d) $y = 2x + 2$
 Nilai-nilai x : $-2.6 \leq x \leq -2.4$
 $1.5 \leq x \leq 1.7$

24

STATISTIK SELAIN MENENGAH ATAS

1. (a) 8
(b) -0.2

2. 6
3. 157.5
4. Nurul

5. (a)

Batang	Daun
4	9
5	4 8 9
6	2 5 6 8 9 9
7	2 2 3 5 7 8 9 9
8	1 2

Kekunci : 4 | 9 bermakna 49g

- (b) Plot titik

6. median = 2
7. $x = 70$
8. (a) RM20
(b) Median = 20
Min = RM20.25
(c) 25%
9. Median, kerana terdapat nilai ekstrem dalam set data.
10.

(i)	25% daripada pesakit itu adalah lebih muda daripada 40 tahun	/
(ii)	Pesakit paling muda berumur 35 tahun	
(iii)	Umur min bagi pesakit itu ialah 46.25 tahun	/
(iv)	Tiada pesakit yang berumur melebihi 50 tahun	

25

PELAN DONGAKAN

1

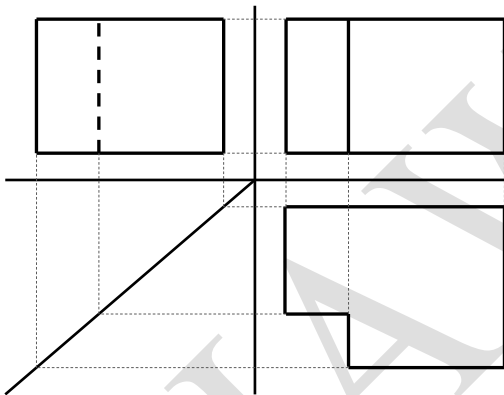

2

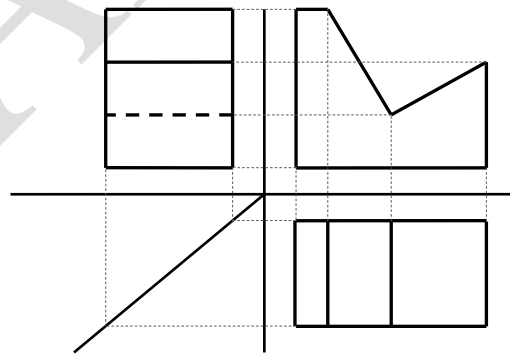

3

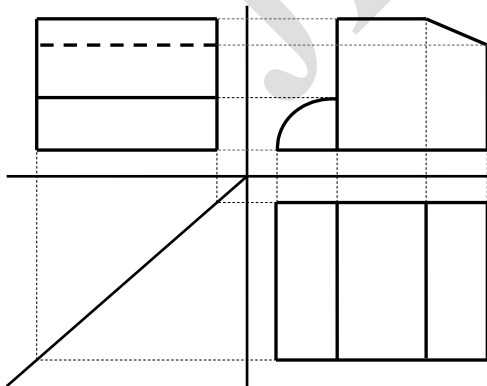

4

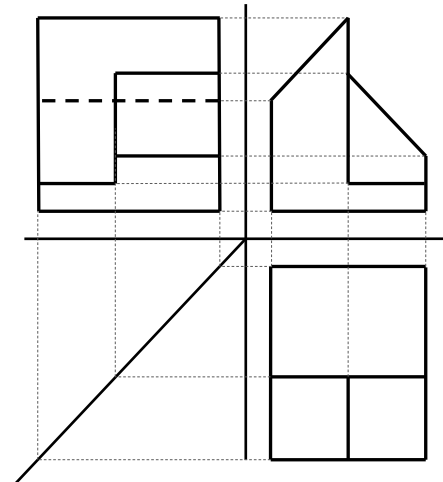

5

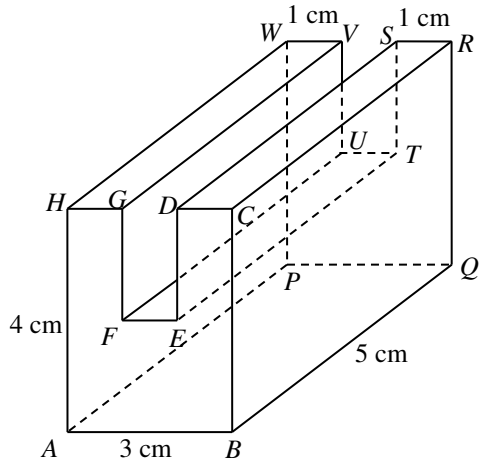

6

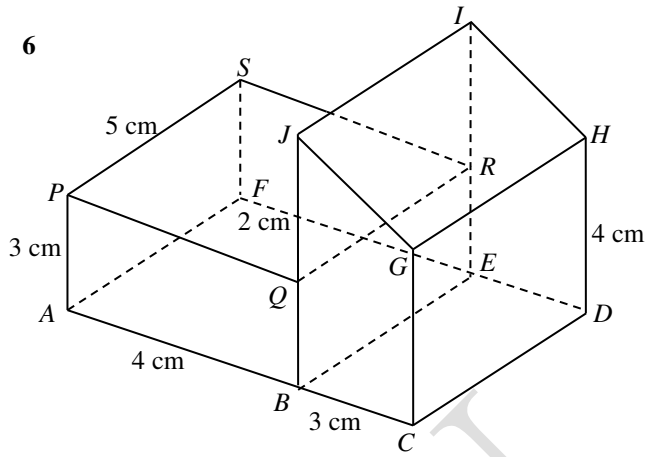

7

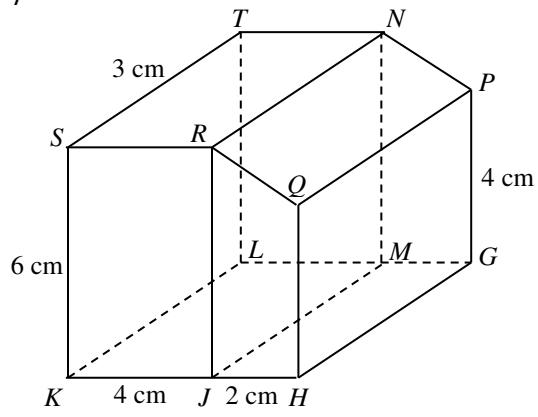

8(a)

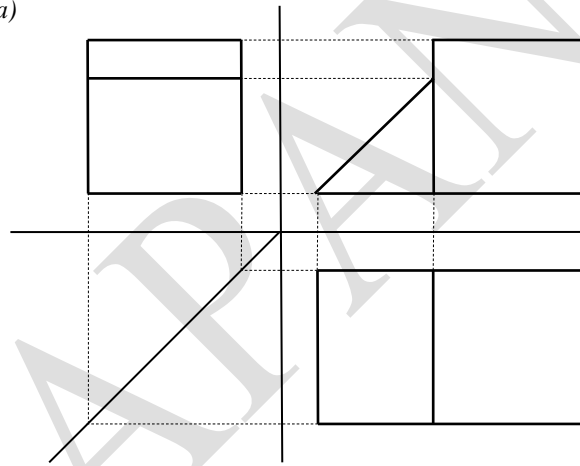

(b) 82

9(a)

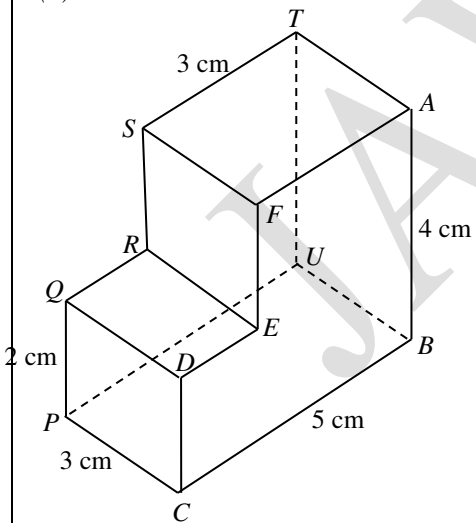

(b) 48

10(a)

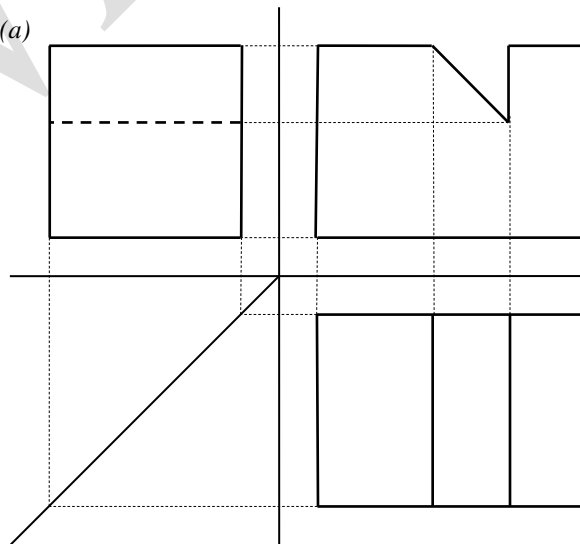

(b) (i) 10

(ii) 2 : 33