



# لاتيه تويي جاوي

نام : \_\_\_\_\_  
كس : \_\_\_\_\_

دسون اوليه: برة حمزة





اي - او

ايقل مودا

\_\_\_\_\_

\_\_\_\_\_

\_\_\_\_\_

\_\_\_\_\_

\_\_\_\_\_

BBM Bariah Hamzah

\_\_\_\_\_

\_\_\_\_\_

1. اي ق ل م و د ا

2. اي ب و اي ت ي ق

3. اوت وت ق وات

4. اوب ت بات وق

5. اي ک و ر ل م ب و

6. ه ا ر ي اي س و ق

7. اي س ي م غ گ ي س

8. ق و م اي ن د ي ا

1. Adi mahu beli epal muda
ادي ماهو بلي ايقل مودا
2. Ibu itik itu rasa lapar.
3. Otot kaki kuda ini kuat.
4. Kakak mahu makan ubat batuk.
5. Ali tidak sabar tunggu hari esok.
6. Ada kaum India di Malaysia.



اءير کلاڻ

1. اءير ک ل ا ق

2. اءيس ک ق ل

3. باءي ق ه ا ت ي

4. راءوت و ا ج ه

5. ا ج ل م اءوت

6. فاءيل ه ي ج ا و

BBM Bariah Hamzah

7. بوءي ه قوت ي ه

8. کاءين با ت ي ق

1. Arif mahu minum air kelapa.
عريف ماهو مينوم اءير كلاق.
2. Ais kepal itu sejuk dan manis.
3. Ayah seorang yang baik hati.
4. Ajal maut ditentukan oleh Tuhan.
5. Cikgu Ali bawa fail hijau.
6. Kain batik kakak banyak corak.



سامبوڱن  
Sambungkan



Blank lines for writing answers to the matching exercise.

BBM Bariah Hamzah

1. س أ ورغ
2. س أوت س
3. س أ ي ك ت
4. س أ ن ك ام
5. ك أ ره
6. ك أم ق ت
7. د أ و ك ور
8. د أ ت س
9. د أ و ل ي
10. د أ ي س ي

1. Ayah saya seorang jurutera.
ایه سای ساورغ جوروترا.
2. Ibu membeli seutas rantai.
3. Mari menuju ke arah kebaikan.
4. Dia mendapat tempat keempat.
5. Burung itu di atas bumbung.
6. Adunan itu perlu diuli.



سامبوغکن  
Sambungkan

\_\_\_\_\_

\_\_\_\_\_

\_\_\_\_\_

\_\_\_\_\_

\_\_\_\_\_

\_\_\_\_\_

\_\_\_\_\_

\_\_\_\_\_

1. م ل ا ئ ك ة

2. ج ب ر ا ئ ي ل

3. م ي ك ا ئ ي ل

4. ع ز ر ا ئ ي ل

5. م س ئ ل ه

6. ع ا ئ ش ة

7. ت ه ن ي ئ ه

BBM Bariah Hamzah

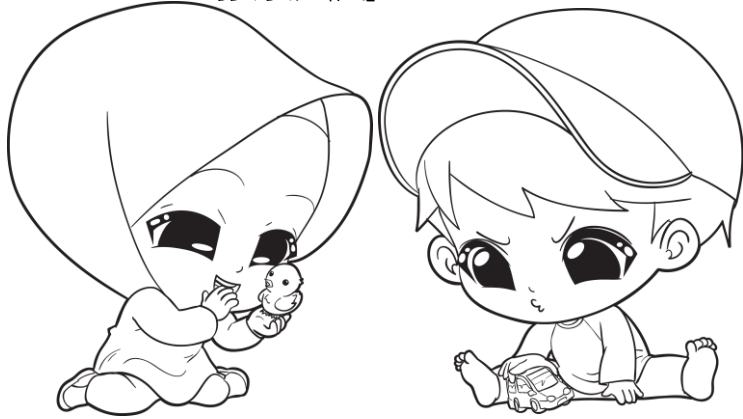



1. Kita beriman kepada sepuluh Malaikat.
کیت برایمان کقد سقولوه ملائکه.
2. Malaikat Jibrail menyampaikan wahyu.
3. Malaikat Mikail menurunkan rezeki.
4. Malaikat Izrail mencabut nyawa.
5. Beritahu saya jika ada masalah.
6. Aishah berasa kurang sihat hari ini.

ا-ها

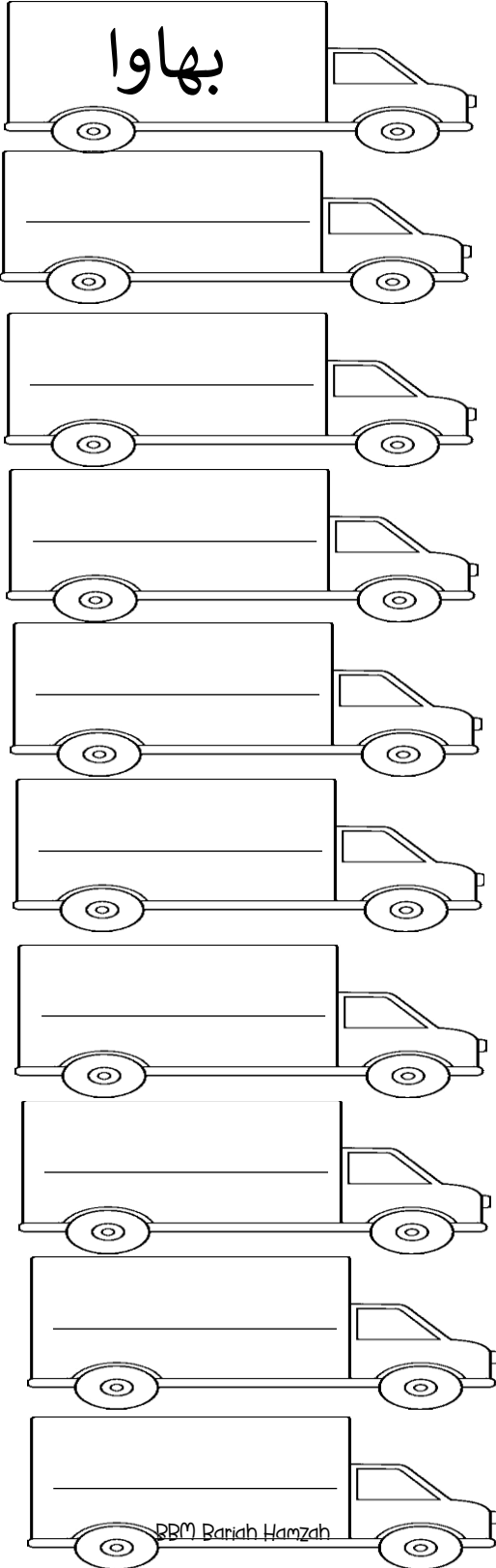

1. ب ه ا و ا

2. ب ه ا ن ي ا

3. چ ه ا ي

4. د ه ا ن ي

5. ب ه ا س

6. ب ه ا ر و

7. ن ي ه ا ر و

8. س ه ا ج

9. ا و س ه ا

10. م ه ا

2. Cahaya Matahari itu terang.

---

---

1. Hidup bahagia dengan berselawat.

---

---

4. Saya pencinta Bahasa Melayu.

---

---

3. Tiba-tiba Kamil berasa dahaga.

---

---

6. Kayu gaharu itu wangi.

---

---

5. Adik ingin kasut baharu.

---

---

BBM Bariah Hamzah

8. Bilik ini untuk solat sahaja.

---

---

7. Jika berusaha pasti berjaya.

---

---

سامبوڭکن

Sambungkan



سليموت

1. س ل ي م و ت

2. س ت ر ي ک

3. ت ي ل ي ف و ن

4. ک و م ق و ت ر

5. ک ل م ب و

6. ک و ا ل ي

7. ق ر ي و ق

8. ق ل ي ت و ق

9. ق ر م ا ي د ا ن ي

10. ت ي ل ي و ي ش ن

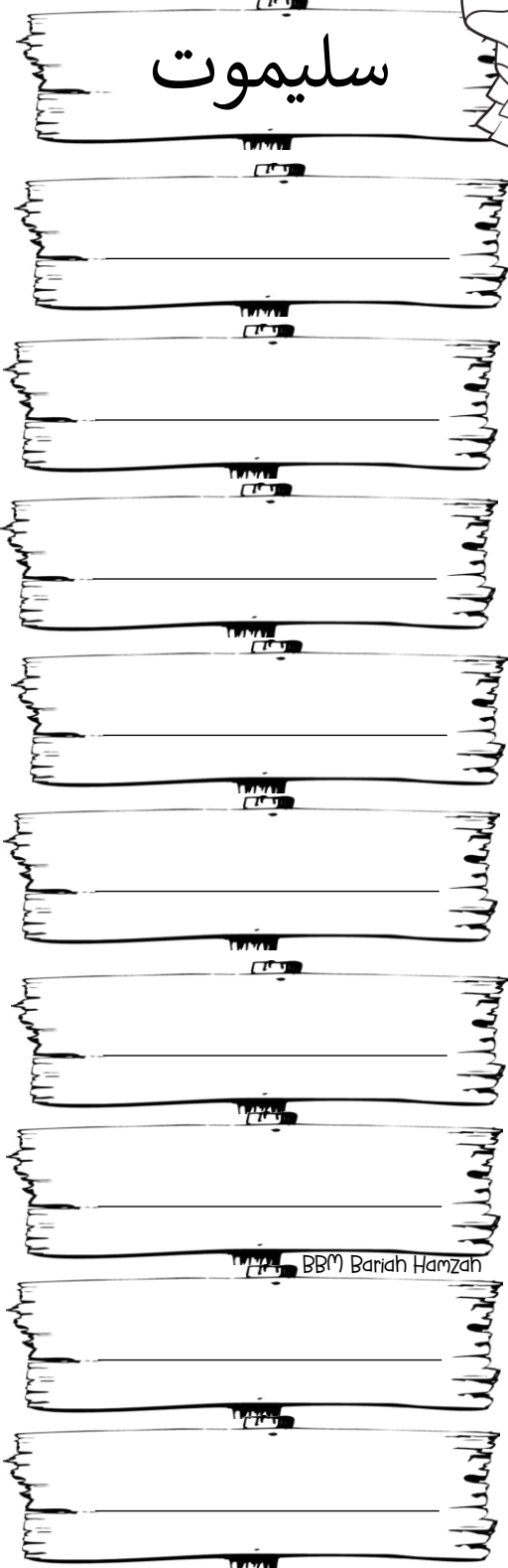

BBM Bariah Hamzah



1. Adik memakai selimut kerana sejuk.

اديق مماكاي سليموت کران سجوق.

2. Ayah menggunakan seterika baharu.

---

3. Kakak menjawab panggilan telefon.

---

4. Abang tertidur di hadapan komputer.

---

5. Kelambu ibu berwarna coklat.

---

6. Dalam periuk itu ada nasi.

---

7. Cikgu memakai pelitup muka.

---

8. Permaidani ini hijau warnanya.

---



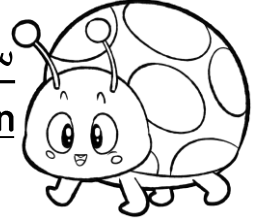

چندرامات

\_\_\_\_\_

\_\_\_\_\_

\_\_\_\_\_

\_\_\_\_\_

\_\_\_\_\_

\_\_\_\_\_

\_\_\_\_\_

\_\_\_\_\_

\_\_\_\_\_

\_\_\_\_\_

\_\_\_\_\_

BEM Bariah Hamzah

1. چ ن درام ات

2. ج و ر و ر ا و ت

3. م ات اه ا ر ي

4. ا غ ک اس ا و ن

5. ق ر ا م و ک ا ر ي

6. ق ل ا غ ي

7. ت و م ب و ه ن

8. ز ر ا ف ه

9. ب ل ا ل غ

10. س س و غ و ت



1. Kakak saya seorang jururawat.

کاکق ساي سآورغ جوروراوت

2. Matahari lebih besar daripada Bumi.

---

3. Cita-cita saya menjadi seorang angkasawan.

---

4. Pelangi akan muncul selepas hujan.

---

5. Dalam hutan ada banyak tumbuhan.

---

6. Zirafah suka makan daun-daun hijau.

---

7. Belalang hinggap di atas rumput.

---

8. Sesungut ada pada serangga.

---

څپڅکوت

1. څ ن څ ک و ت

2. ک م ي ج ا

3. ال م اري

4. م ل ا ي و

5. س ک و ل ه

6. ل ن چ ا ن

7. څ م ب اري س

8. څ م ا د م

9. څ څ ا و س

10. ک ا و ا س ن

BBM Bariah Hamzah





1. Ibu mencari **penyangkut** baju.

ايبو منچاري **فيڠكوت** باجو.

2. Abang memakai **kemeja** baharu.

---

3. Bapa Ali sedang mengecat **almari**.

---

4. Murid perlu memakai Baju **Melayu**.

---

5. **Lencana sekolah** ini belum dijahit.

---

6. Ayu membeli sebatang **pembaris**.

---

7. **Pemadam Hadi** sudah hilang.

---

8. Adira adalah seorang **pengawas sekolah**.

---

جاويكن  
Jawikan

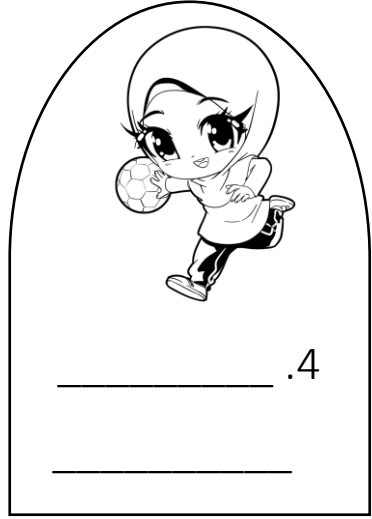
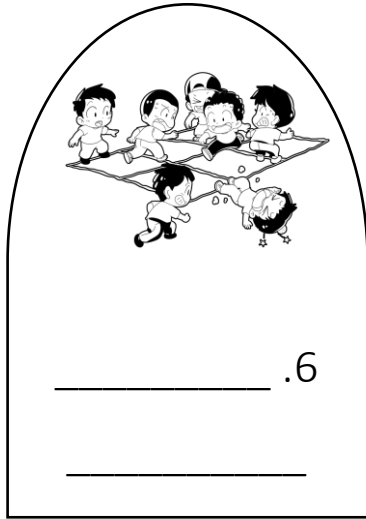
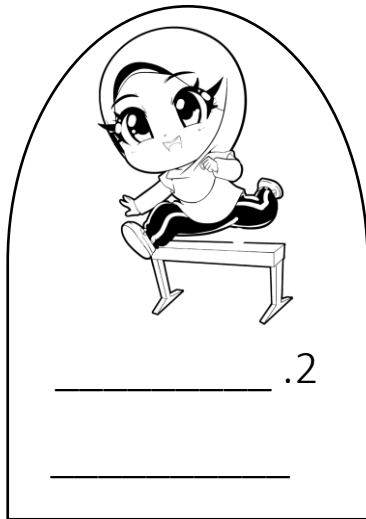

BBM Bariah Hamzah

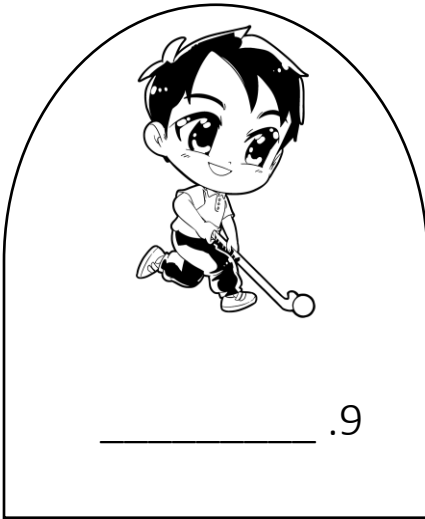



1. Hadi sedang bermain **bola sepak**.

هادي سدغ برماين بولا سيفق.

2. Iman menyertai sukan **lompat pagar**.

---

3. Fahim suka bermain **bola keranjang**.

---

4. Sukan **bola baling** ada di sekolah saya.

---

5. **Bola jaring** untuk murid perempuan.

---

6. Budak-budak sedang bermain **galah panjang**.

---

7. Gelanggang **badminton** ini luas.

---

BBM Bariah Hamzah

8. Di manakah kayu **hoki** kamu?

---

ڦرڪاٽاءِ ن 3 سوڪو ڪاٽ

جاوڻڪن  
Jawikan

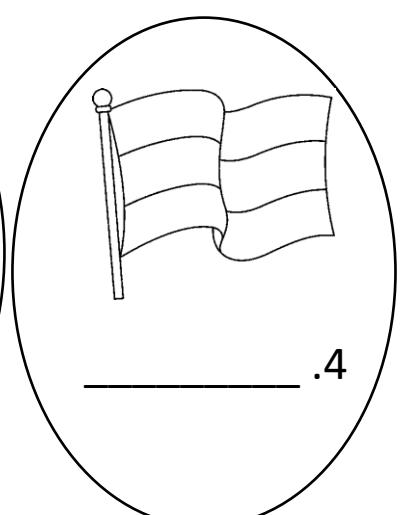
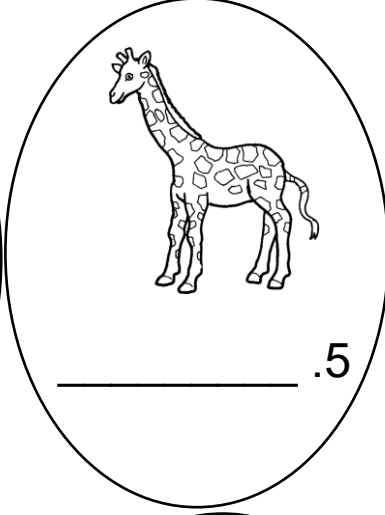
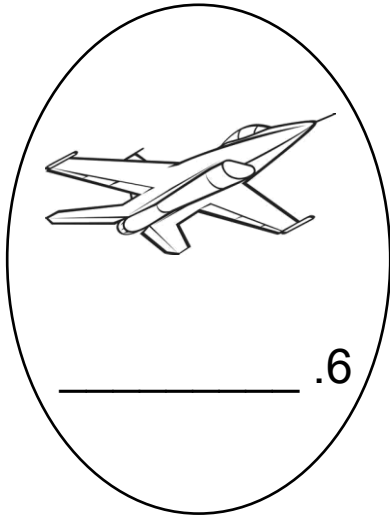
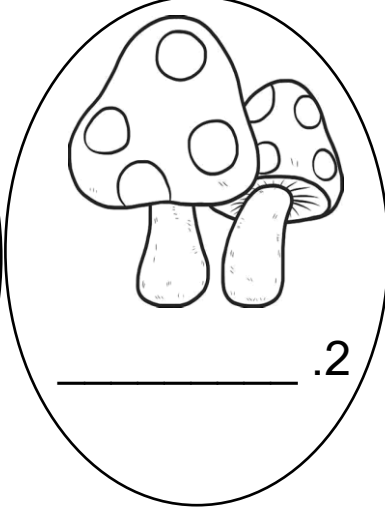
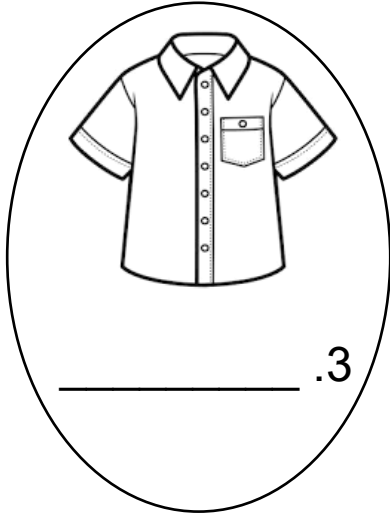

BBM Bariah Hamzah

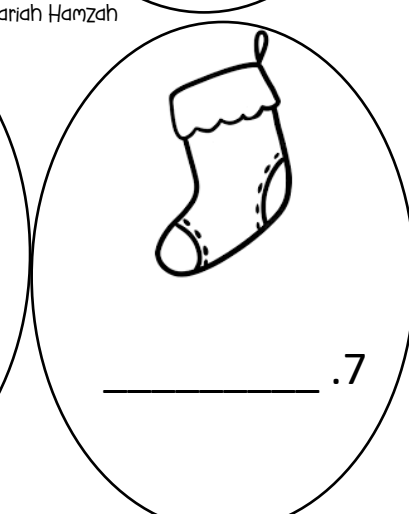
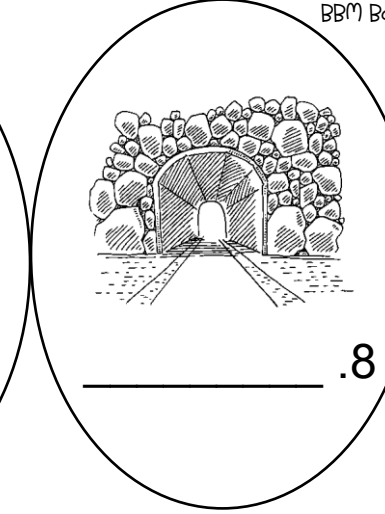
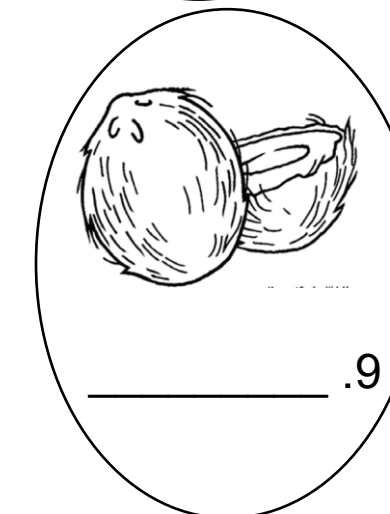



1. **Pelangi** ada tujuh warna.

قلاغي اد توجوه ورنا.

2. Rani terjumpa sebatang **cendawan**.

---

3. Baju **kemeja** ayah sudah lusuh.

---

4. Pengawas sedang menaikkan **bendera**.

---

5. Ada lima ekor **zirafah** di zoo.

---

6. **Pesawat** itu terhempas ke Bumi.

---

7. Adik memakai **stokin** hijau.

---

BBM Bariah Hamzah

8. Kereta itu memasuki **terowong**.

---